

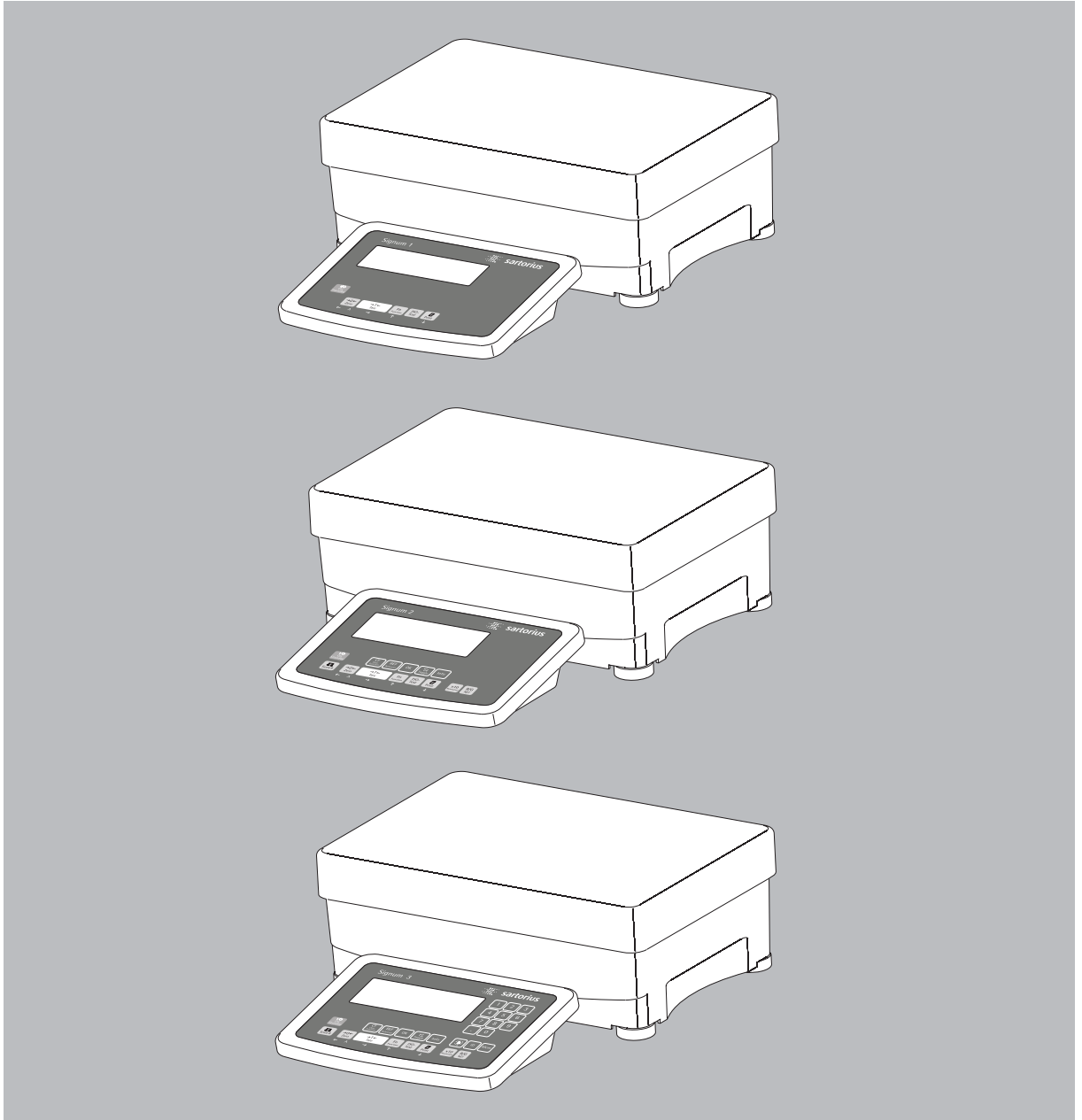

Operating Instruction

Sartorius Signum 1 | Signum 2 | Signum 3

Models SIWR | SIWA | SIWS
Complete Scales



Intended Use

Signum 1, 2 and 3 are precise and rugged complete scales that give you reliable weighing results.

The Signum Series of compact scales includes models with strain-gauge weighing systems as well as versions equipped with monolithic technology, using the principle of electromagnetic force compensation.

These compact industrial scales offer the following special features:

- Rugged and durable Sartorius quality
- Flexible options for display unit installation
- Wide range of configuration options for customized operation
- Variety of optional data interfaces
- Optional IP65 protection from dust and jets of water
- Optional versions for use in zone 2 and 22 hazardous areas
- High quality workmanship and materials
- Choice of application levels
- Available in weighing capacities between 3 kg and 60 kg; choice of resolutions available for each capacity
- Verifiable models in accuracy classes I (SIWS) and III (SIWR)
- Preload values can be defined (for equipment installed on the scale)

Additional features include:

- Large keys with positive click action
- Numeric and alphabetic input
- Large backlit 14-segment display
- Connectivity for two weighing platforms (digital platform or, using an optional A/D converter, analog platform)

Advantages in routine weighing tasks:

- Fast response times
- Independence from location of platform installation
- Designation of weight values with up to 4 lines of alphanumeric text
- Flexibility afforded by diversity of interfaces
- Security through password protection

Range of Models

Three different types of weighing technology are used in the Signum Series, offering different performance levels:

Signum Regular (SIWR Models)

- Standard weighing system (all SIWR models)
- Resolutions up to 35,000d
- Models verified at the factory for use in legal metrology, Class III , with: 2×3000/3500e (dual range); 1×6000/7500e and 1×3000e (single range)
- The single-range scales with variable scale intervals are available with your choice of fixed or adjustable fine range

Signum Advanced (SIWA Models)

- Mechatronic weighing system (all SIWA models)
- Resolutions up to 65,000d

Signum Supreme (models SIWS)

- Monolithic weighing system (all models SIWS)
- Resolutions up to 350,000d
- Models verified at the factory for use in legal metrology, Class II , with: 1×30,000e (e=d); 1×6000e; 35,000e (single and dual range); 16,000e (single and dual range, each with internal motorized calibration weight)
- The single-range scales with variable scale intervals are available with your choice of fixed or adjustable fine range

Signum Regular, Advanced and Supreme models are all available with applications levels 1, 2 and 3.

Symbols

The following symbols are used in these instructions:

- denotes general operating instructions
- indicates instructions for exceptional cases
- > describes the outcome of an operating step
- ⚠ indicates a hazard

For technical advice on applications, call the hotline at:

Phone (in Germany):

+49(0)551.308.4440

Fax (in Germany):

+49(0)551.308.4449

Contents

2	Intended Use	81	Configuring Printouts
4	Warnings and Safety Precautions	83	Interface Port
5	Getting Started	84	Connecting a Second Weighing Platform
5	Unpacking the Scale	84	Pin Assignment Chart
5	Equipment Supplied	84	Pin Assignments for COM1
5	Installation	84	Pin Assignments for UniCOM
5	Conditioning the Scale	85	Wiring Diagram (Display and Control Unit \leftrightarrow Computer)
5	Checking the Geographical Data Entered for Use in Legal Metrology	86	Configuring the Data Interface as a COM Port
6	Installing the Display and Control Unit	86	Data Input Format (Commands)
8	Connecting the Scale to AC Power	87	Data Output Format
8	Leveling the Weighing Platform	88	Configuring the Data Interface as a Printer Port
9	General View of the Equipment	89	Automatic Data Output (SBI)
9	Display and Keypad	90	GMP-compliant Printouts
9	Back Panel	91	Error Codes
10	Operating Design	92	Care and Maintenance
10	Input	92	Recycling
10	Keypad Input	93	Overview
11	Input Through the Digital Control Port	93	Common Specifications
11	Input Using a Bar Code Scanner or External Keyboard	94	Signum Model Designator
12	Display Modes	95	Details on Available Resolutions
13	Measured Value Display	96	Model-specific Specifications
13	Saving Data in Weighing Mode	98	Dimensions (Scale Drawings)
14	Operating Menu Navigation	99	Accessories
15	Error Codes	101	Declarations of Conformity
15	Data Output	104	EC Type-Approval
15	Saving Data	105	Plates and Markings
16	Configuration	108	Index
16	Setting the Language		
17	Configuring a Password		
18	Operating Menu Overview		
38	Operation		
38	Basic Weighing Function		
38	Weighing $\Delta\Delta$		
38	Device Parameters		
40	Tare Function in Weighing		
40	Numeric Input for Weighing		
41	Weigh with Variable Tare Values		
42	Calibration and Adjustment		
43	Setting the Preload		
43	Clearing the Preload		
46	SQmin Function		
48	Data ID Codes		
50	Combining Application Programs		
51	Counting		
55	Neutral Measurement		
58	Averaging		
61	Weighing in Percent		
64	Checkweighing		
67	Checkweighing toward Zero		
68	Classification		
71	Totalizing		
74	Net-total Formulation		
78	Examples of Application Combinations in Signum 3		
80	Product Data Memory in Signum 3		
			Appendix
			General Password

Warnings and Safety Precautions

Signum scales comply with the European Council Directives as well as international regulations and standards for electrical equipment, electromagnetic compatibility, and the stipulated safety requirements.

- To prevent damage to the equipment, read these installation instructions carefully before using your Signum scale.
- ⚠ Do not use this equipment in hazardous areas. If you use electrical equipment in installations and under ambient conditions subject to stricter safety standards than those described in the manual, you must comply with the provisions as specified in the applicable regulations for installation in your country.
- ⚠ The display and control unit may be opened only by authorized service technicians who have been trained by Sartorius and who follow Sartorius' standard operating procedures for maintenance and repair work.
- ⚠ Make absolutely sure to unplug the display and control unit from power before you connect or disconnect any electronic peripheral devices to or from the interface port.
- On request, Sartorius will provide information on the minimum operating specifications (in accordance with the standards for defined immunity to interference).
- ⚠ If the equipment is exposed to excessive electromagnetic interference, it can affect the value displayed. Once the disturbance has ceased, the instrument can be used again in accordance with its intended purpose.
- Connect only Sartorius accessories and options, as these are optimally designed for use with your Signum scale.
- Warning when using pre-wired RS-232 connecting cables: RS-232 cables purchased from other manufacturers often have pin assignments that are incompatible with Sartorius products. Be sure to check the pin assignments against the chart in this manual before connecting the cable, and disconnect any lines identified differently from those specified by Sartorius.

- If there is visible damage to the equipment or power cord, unplug the equipment and lock it in a secure place to ensure that it cannot be used for the time being.
- Use only extension cords that meet the applicable standards and have a protective grounding conductor.
- ⚠ Disconnecting the ground conductor is prohibited.
- Note on installation:
The operator shall be responsible for any modifications to Sartorius equipment and for connections of cables not supplied by Sartorius and must check and, if necessary, correct these modifications.

If Option L8 (24-volt module) for connection to low-voltage sources is used, be sure to comply with the requirements for safety extra low voltage (SELV) and protective extra low voltage (PELV).

NOTE:

This equipment has been tested and found to comply with the limits pursuant to part 15 of FCC Rules. These limits are designed to provide reasonable protection against harmful interference. This equipment generates, uses and can radiate radio frequency energy and, if not installed and used in accordance with these instructions, may cause harmful interference to radio communications. For information on the specific limits and class of this equipment, please refer to the Declaration of Conformity. Depending on the particular class, you are either required or requested to correct the interference. If you have a Class A digital device, you need to comply with the FCC statement as follows:

“Operation of this equipment in a residential area is likely to cause harmful interference in which case the user will be required to correct the interference at his own expense.” If you have a Class B digital device, please read and follow the FCC information given below:
“[...] However, there is no guarantee that interference will not occur in a particular installation. If this equipment does cause harmful interference to radio or television reception, which can be determined by turning the equipment off and on, the user is encouraged to try to correct the interference by one or more of the following measures:

- Reorient or relocate the receiving antenna.
- Increase the separation between the equipment and receiver.

- Connect the equipment into an outlet on a circuit different from that to which the receiver is connected.
- Consult the dealer or an experienced radio/TV technician for help.”

Before you operate this equipment, check which FCC class (Class A or Class B) it has according to the Declaration of Conformity included. Be sure to observe the information of this Declaration.

- Do not expose the equipment to aggressive chemical vapors or to extreme temperatures, moisture, shocks, or vibration.
- Clean your Signum scale only in accordance with the cleaning instructions (see “Care and Maintenance”).
- If you have any problems with your Signum scale: contact your local Sartorius office, dealer or service center.

IP Rating

Industrial protection ratings for the housing:

- All models are rated to IP43 (if Option I65 was ordered; the equipment is rated to IP65)
- The IP43 (or optional IP65) protection rating for the display and control unit is ensured only if the rubber gasket is installed and all connections are fastened securely (including the caps on unused sockets). Weighing platforms and equipment must be installed and tested by a certified technician.
- If you install an interface port or battery connector after setting up your Signum, keep the protective cap(s) in a safe place to be used for protecting the interface port or battery connector when not in use, or prior to shipment. Do not leave the interface ports uncovered. If you are not using a particular connector, replace the cap to protect the data interface from vapors, moisture and dust or dirt.

Using the Equipment in Legal Metrology

- If the scale is to be verified, make sure to observe the applicable regulations regarding verification.
- If any of the verification seals are damaged, make sure to observe the national regulations and standards applicable in your country in such cases. In some countries, the equipment must be re-verified.

Getting Started

Unpacking the Scale

- After unpacking the equipment, please check it immediately for any external damage.
- If you detect any damage, proceed as directed in the chapter entitled “Care and Maintenance,” under “Safety Inspection.”
- Save the box and all parts of the packaging for any future transport. Unplug all connected cables before packing the equipment.

Equipment Supplied

- Complete scale
- Operating instructions (this manual)
- Special accessories as listed on the bill of delivery, if ordered

Installation

Choose a location that is not subject to the following negative influences:

- Heat (heater or direct sunlight)
- Drafts from open windows and doors
- Extreme vibrations during weighing
- Excessive moisture

Conditioning the Scale

Moisture in the air can condense on cold surfaces whenever the equipment is moved to a substantially warmer place. To avoid the effects of condensation, condition the scale for about 2 hours at room temperature, leaving it unplugged from AC power.

Equipment not in Use

Switch off the equipment when not in use.

Checking the Geographical Data Entered for Use in Legal Metrology (SIWR Models Only)

Preparation

(See also the “Device Information” menu items listed under “Operating Menu Overview” in the chapter entitled “Configuration.”)

- Press the I/O key to turn on the scale
- While all segments are lit, press the T key
 - > PPPL is displayed
- To select “Device-specific information,” press Fn repeatedly; press T to confirm
- To switch the display between information on weighing platform 1 and weighing platform 2, press Fn repeatedly; press T to confirm
 - > View geographical data (configured prior to verification); for example:
Latitude (in degrees): $51^{\circ}4'$
Altitude (in meters): 513^{m}
or
Gravitational acceleration (in m/s^2):
 $9.810^{\text{m/s}^2}$

The scale can be used in legal metrology anywhere in Germany if the geographical data is as follows:

- Latitude: 51.00 degrees
 - Altitude: 513 m
- This data corresponds to the following value:
- Gravitational acceleration: 9.810 m/s^2

These values are calculated for Germany based on a mean value for the Earth’s acceleration. The greater the precision of the geographical data entered, the greater the precision achieved with the weighing instrument; the tolerance range, however, is restricted accordingly (see above).

The tolerance ranges, for example for a scale with 3000e, are as follows:

- ± 100 for the latitude, and
- ± 200 for the elevation above sea level.

⚠ If used outside the specified zone, the scale must be re-verified for use in legal metrology: Please contact an authorized service technician.

Getting Started

Installing the Display and Control Unit

The following options are available for installing the display and control unit:

- Attached to the front of the weighing platform
- On a column; part number YDH01P (optional)

Fastening the display and control unit to the weighing platform:

- Guide the display and control unit onto the retainer bracket.
- Level the weighing platform (see page 7).

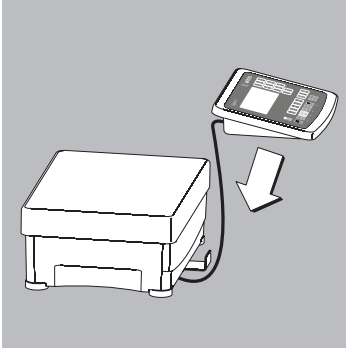

Operating the display and control unit separately:

- Turn the weighing platform over and place it on a soft surface to avoid damaging the weighing system.
- Remove the display and control unit retainer bracket.
- Take the cable out of the cable channel.
- Turn the weighing platform right side up and place it so that it rests on its feet.
- Level the weighing platform (see page 8).

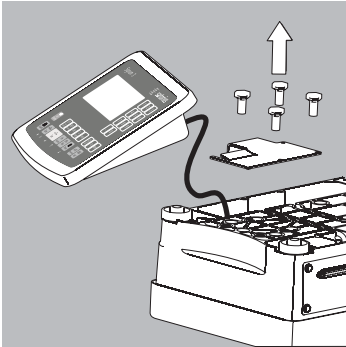

Installing the display and control unit on the YDH01P column:

- Turn the weighing platform over and place it on a soft surface to avoid damaging the weighing system.
- Remove the display and control unit retainer bracket.
- Take the cable out of the cable channel.

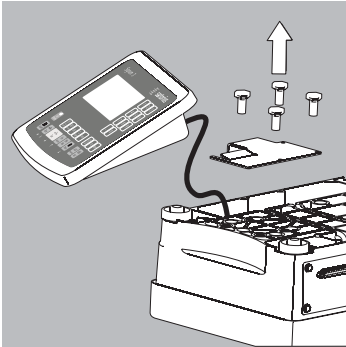

- Use the four hexagonal screws provided (M4×8) to attach the column to weighing platform (back panel facing downward).
- Turn the weighing platform right side up and place it so that it rests on its feet.

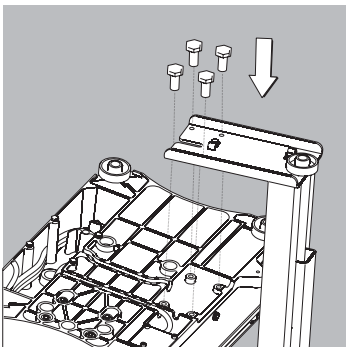

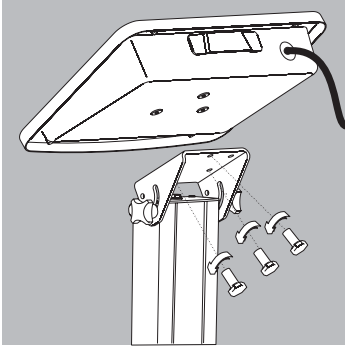

- Loosen the two locking bolts at the top of the column to facilitate installation of the display and control unit.
- Use the 6 hexagonal screws to attach the display and control unit to the top of the column.
- Adjust the display and control unit to the desired angle and tighten the locking bolts at the top of the column.

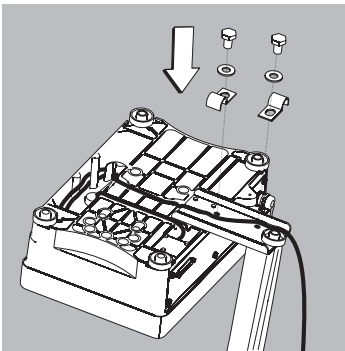

- A recessed space is provided in the scale base, accessed from the bottom of the scale, for any excess length of cable.
- Guide the connecting cable along the channel on the bottom of the weighing platform.
- Use the cable clamps provided to affix the cable that connects the display and control unit to the weighing platform to the bottom of the column.
- Turn the weighing platform right side up and place it so that it rests on its feet.

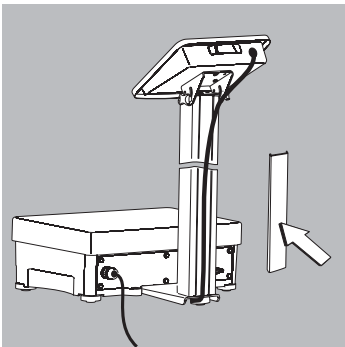

- Attach the cable retainer to affix the cable connecting the display and control unit to weighing platform to the back of the column.

Getting Started

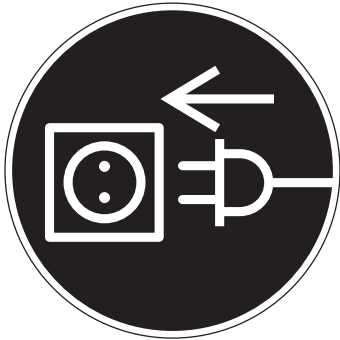

Connecting the Scale to AC Power

- Check the voltage rating and the plug design.
- The equipment is powered through the installed power cord. The power supply is built into display and control unit, which can be operated with a supply voltage of 100 V to 240 V. Make sure that the voltage rating printed on the manufacturer's ID label is identical to that of your local line voltage. If the voltage specified on the label or the plug design of the AC adapter do not match the rating or standard you use, please contact your Sartorius office or dealer. The power connection must be made in accordance with the regulations applicable in your country.

To power a device of protection class 1, plug the power cord into an electrical outlet (mains supply) that is properly installed with a protective grounding conductor (protective earth = PE). The power plug or a different, suitable disconnecting device for the power must be easily accessible.

Safety Precautions

If you use an electrical outlet that does not have a protective grounding conductor, make sure to have an equivalent protective conductor installed by a certified electrician as specified in the applicable regulations for installation in your country. Make sure the protective grounding effect is not neutralized by use of an extension cord that lacks a protective grounding conductor.

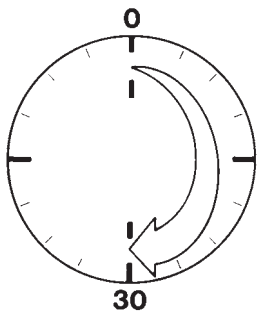

Warmup Time

To deliver exact results, the scale must warm up for at least 30 minutes after initial connection to AC power or after a relatively long power outage. Only after this time will the scale have reached the required operating temperature.

- Using Equipment Verified as Legal Measuring Instruments in the EU*:
 - Make sure to allow the equipment to warm up for at least 24 hours after initial connection to AC power or after a relatively long power outage.

Connecting a Bar Code Scanner (Accessory; Order No. YBR02FC)

- △ Disconnect the display and control unit from AC power (unplug the AC adapter)
- Installation:
 - please see "Pin Assignment Charts" in this manual (implemented via the YCC02-BR02 connecting cable or as Option M8)

Leveling the Weighing Platform

Purpose:

- To compensate for uneven areas at the place of installation
- To ensure that the equipment is placed in a perfectly horizontal position for consistently reproducible weighing results

Always level the weighing platform again any time after it has been moved to a different location.

- Level the weighing platform using the four leveling feet. Turn the feet until the air bubble is centered in the level indicator.
- Check to ensure that all leveling feet rest securely on the work surface.
 - > Each of the leveling feet must support an equal load.
 - > Adjusting the leveling feet:
 - To raise the weighing platform, extend the leveling feet (turn counterclockwise).
 - To lower the weighing platform, retract the leveling feet (turn clockwise).

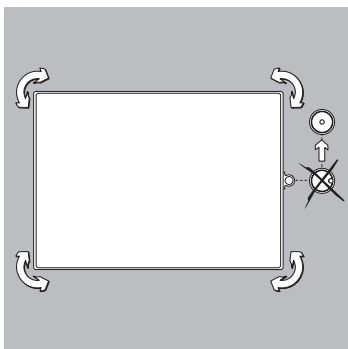

General View of the Equipment

Signum 1

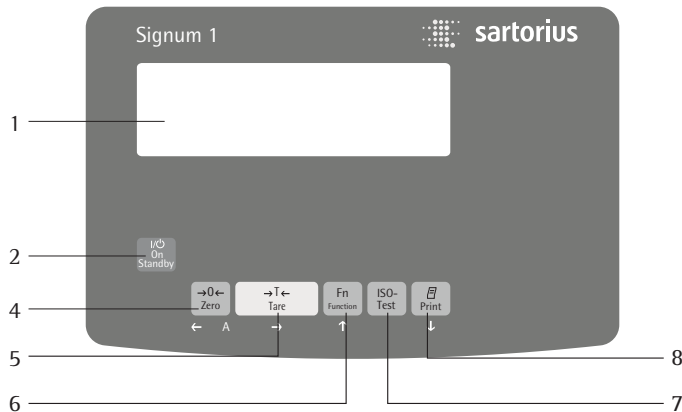

Signum 2

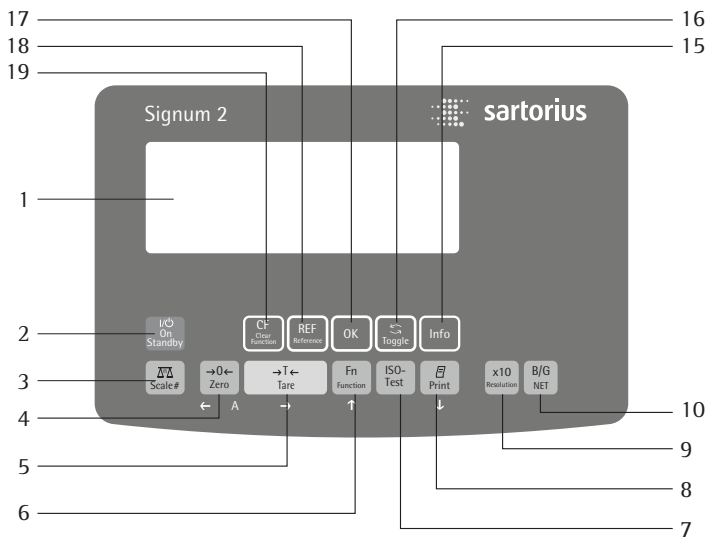

Signum 3

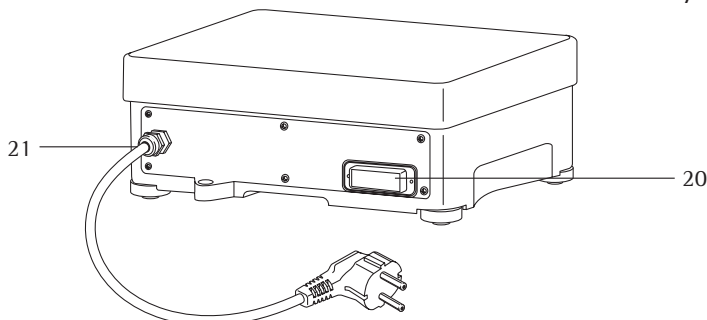
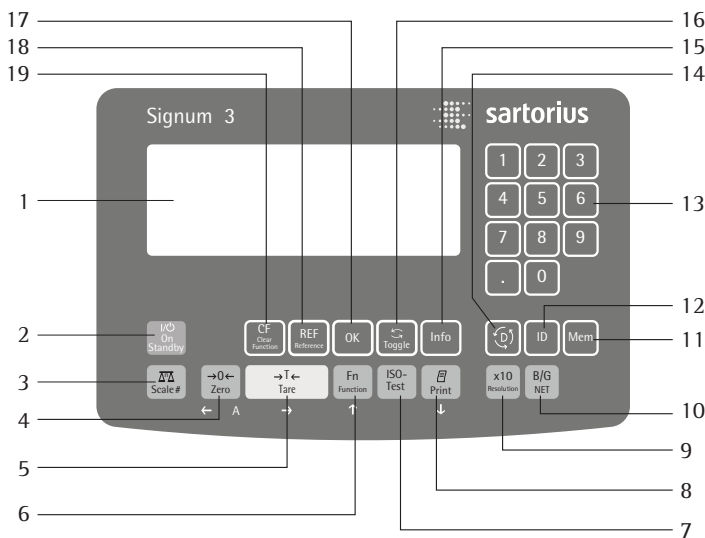

Display and Keypad

- 1 Display (for details, see the chapter entitled "Operating Design")
- 2 On/off key
- 3 Toggle key (toggle display between weighing platforms)
- 4 Zero key
- 5 Tare key
- 6 Function key (toggle between gross and net values)
- 7 Start calibration or adjustment
- 8 Print key (data output)
- 9 Toggle unit between normal and 10-fold higher resolution
- 10 View gross value (net value plus tare)
View net value (gross value minus tare)
- 11 Save data
- 12 ID key (for entering operator ID)
- 13 Alphanumeric keypad
- 14 Toggle between application program and application-specific information
- 15 Info key (shows ID codes and tare values)
- 16 Toggle key (function depends on application)
- 17 OK key (function depends on application)
- 18 Reference value key (function depends on application)
- 19 Clear function key (function depends on active application)

Back Panel

- 20 RS-232C interface (COM1) (standard equipment)
- 21 Power cord connection

Operating Design

Keys

Operation of the Signum 1, Signum 2 or Signum 3 scale involves just a few keys. These keys have one function during measurement and another during configuration. Some of the keys have one function when pressed briefly, and another activated by pressing and holding the key for longer than 2 seconds.

If a key is inactive, this is indicated as follows when it is pressed:

- The error code "-----" is displayed for 2 seconds. The display then returns to the previous screen content.

You can use Signum 2 or 3 to collect weight values from two weighing platforms, calculate and display weight values using application programs, and assign IDs to the samples weighed.

Configure the display and control unit first, using the operating menu to prepare the desired application program (printer settings, etc.). Then you can begin weighing.

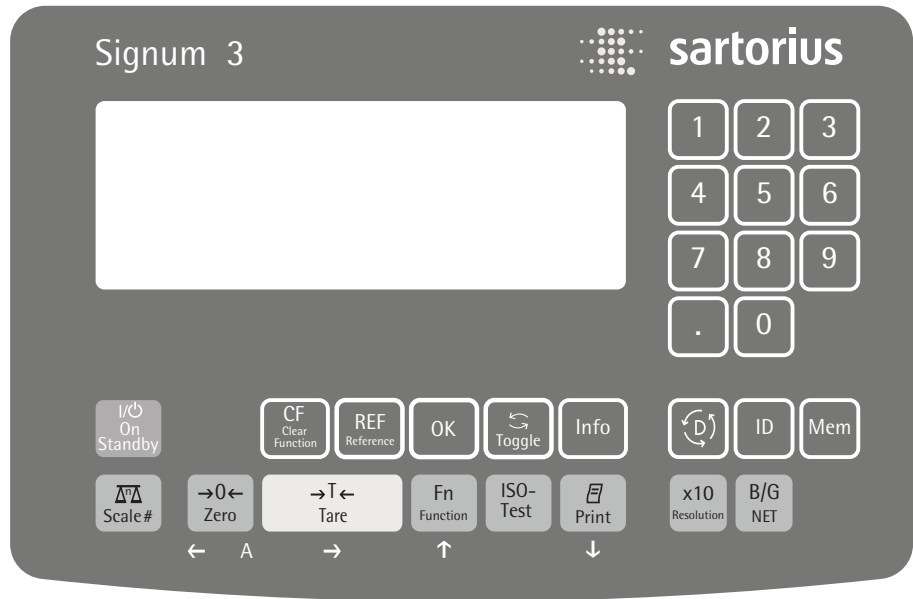

Operating Elements: Signum 3

Input

Keypad Input

Labeled Keys

Some keys have a second function, activated by pressing and holding the key for over two seconds. Whether a function is available depends on the operating state and operating menu settings.

On/off (in standby mode, OFF is displayed).

Signum 2 and 3 only:
 If a second weighing platform is connected, this key toggles the display between the two readouts.

- Zero the scale
- Cancel calibration/adjustment

- Tare the scale

Toggle between 1st and 2nd weight unit, or gross and net values, or normal and 10-fold higher resolution, depending on operating menu settings (depends on model)

Start calibration or adjustment

- To print: press briefly.
- To print GMP footer: Press and hold (> 2 seconds)

Signum 3 only:
 To toggle the scale to Info mode

Signum 3 only:
 ID key (for entering operator ID)

Signum 2 and 3 only:
 Toggle unit between normal and 10-fold higher resolution

Signum 2 and 3 only:
 Net-gross value key

Signum 2 and 3 only:
 Toggle between display modes within an application program

Signum 2 and 3 only:
 Lets you modify reference values

Signum 2 and 3 only:
 Saves a value or starts an application program.

Signum 3 only:
 Saves a value in product data memory

Signum 3 only:
 Toggle applications

Info Signum 2 and 3 only:
Press to view either application data or manual tare values, depending on the key pressed subsequently (e.g., $\rightarrow T \leftarrow$)

CF Signum 2 and 3 only:
– Quit an application or delete an input character

Signum 3 only:
 $\boxed{0}$, $\boxed{1}$, $\boxed{2}$... $\boxed{9}$
Enter numbers, letters and other characters

Numeric Input via the Keypad (Signum 3 Only)

- To enter numbers (one digit at a time):
Press $\boxed{0}$, $\boxed{1}$, $\boxed{2}$... $\boxed{9}$
- To save input:
Press the required key (e.g., $\rightarrow T \leftarrow$) to save manual tare input
- To delete a digit:
Press **CF**

Loading a Tare Value from the Weighing Platform

To save the weight on the weighing platform as a tare weight:
Press the $\rightarrow T \leftarrow$ key

Input Through the Digital Control Port

You can connect a remote hand switch or foot switch to the input control line, for use with all application programs. Assign one of the following functions to this switch in the Setup menu, under Device parameters - Control input (CTRL ID):

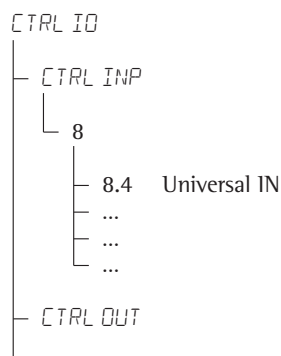

For a detailed list of menu items, please see the chapter entitled "Configuration."

Input over the ASCII Port

See page 86, "Data Input Format."

Input using a Bar Code Scanner or External Keyboard

Input over a bar code scanner or keyboard is handled by the Signum in the same manner as keypad input:

- Weight values for tare memory
- Reference weight values for the Counting, Neutral Measurement and Weighing in Percent applications
- Numeric values
- Product identifiers

Signum 2 and 3 only:
Bar code scanner input can trigger a function or load information for display on the display and control unit. You can configure this option in the operating menu under *BARCODE*.

1) Value stored directly:

- REF
- TARE
- ID1

2) INPUT:

Scan bar code and then press the corresponding key

3) HEADER:

Allocation of the first value is encoded in the bar code:

- REF
- TARE
- ID1-4

Coding available on request.

Operating Design

Display Modes

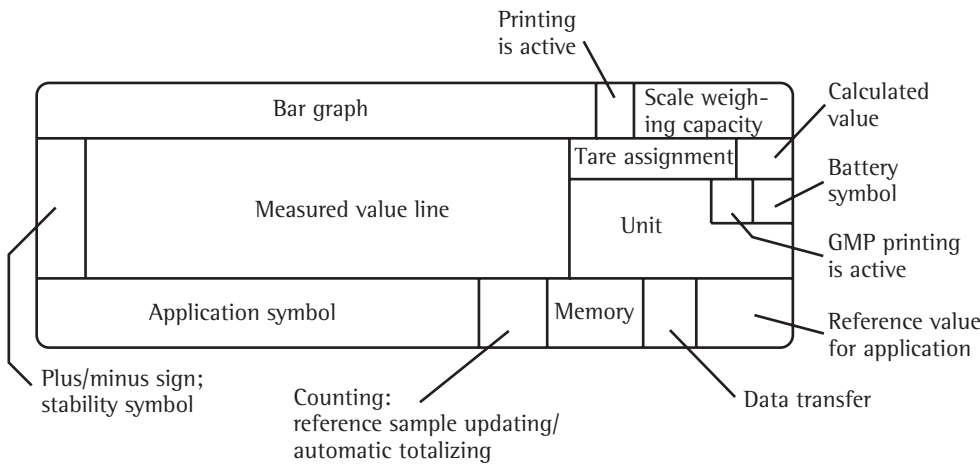

- There are two display modes:
- Normal operation (weighing mode)
 - Operating menu (for configuration).

Weighing Mode: Display of Measured and Calculated Values

Application, printing and battery symbols:

The application symbol indicates the selected program; for example:

- ☰ Counting application. Other symbols shown here include:
- ☒ Printing mode active
- ☒ GMP printing mode active





The battery symbol  indicates the charge level of the external rechargeable battery.

Bar graph:

The bar graph shows the percentage of the weighing platform's capacity that is "used up" by the load on the scale (gross value).

- 0% Lower limit
- 100% Upper limit

The following symbols indicate tolerance levels for Checkweighing:

-  Bar graph with 10% markings
-  Minimum
-  Target
-  Maximum

Plus/minus sign:

+ or **-** for weight value or calculated value,
→0← zero-setting symbol: when the weighing platform is zeroed or tared, indicates that the deviation from zero is no more than 0.25e (verified models only).

Measured value/result line:

This field shows weight values, calculated values and input characters.

Unit and stability:

When the weighing system reaches stability, the weight unit or the unit for a calculated value is displayed here.

Tare in memory, calculated values:

The following symbols may be displayed here:

-  Calculated value (not valid in legal-for-trade applications)
- NET Net value (gross value minus tare)
- B/G Gross value (net value plus tare)

Data in tare memory, calculated values, designation of the active weighing platform:

- PT Identification of manual tare input (using a bar code scanner) when viewing tare information
- WP 1 Display of the active weighing platform when 2 platforms are connected. Symbol flashes to prompt adjustment of the weighing platform, if the isoCAL function is active

Application symbols:

For input and display of detailed information; e.g., for the selected application.

- ☰ Counting
- ☒ Weighing in Percent
- ☒ Averaging (Animal Weighing)
- ☒ Checkweighing
- ☒ Classification
- ☒ Checkweighing toward Zero
- ☒ Totalizing
- ☒ Net-total Formulation

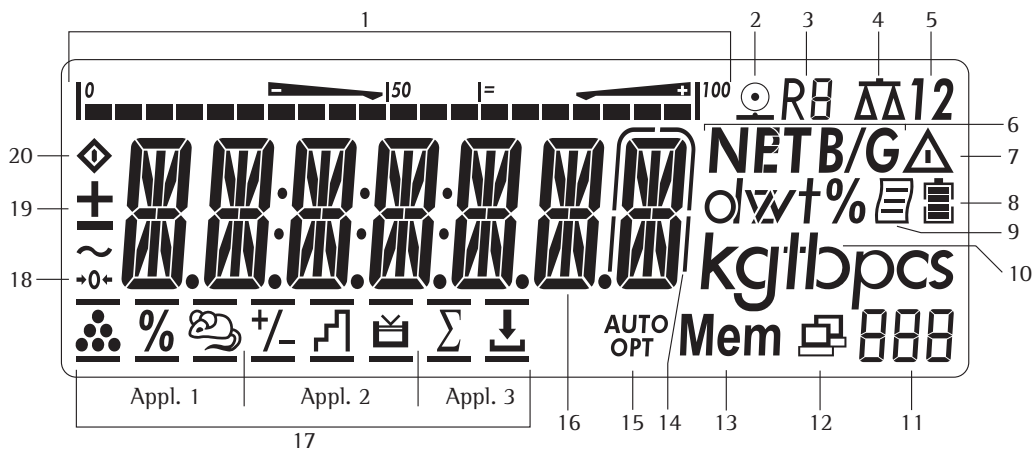

Display in Weighing Mode

The illustration above depicts all of the main display elements and symbols that can be shown during weighing.

- | | | |
|--|---|--|
| <p>1. Bar graph</p> <ul style="list-style-type: none"> - Shows the percentage of the weighing platform's capacity that is "used up" by the load on the scale (gross value), or - Shows the measured value in relation to a target value (with the Checkweighing or Classification application) <p>2. Printing in progress</p> <p>3. Display of the range on multiple-range instruments</p> <p>4. Indicates active weighing platform; flashes to prompt calibration/adjustment</p> <p>5. Selected weighing platform (1 or 2)</p> <p>6. Indicates whether the value on the main display is net or gross (with tare in memory or preset tare)</p> <p>7. Identifies the value on the main display as calculated (value not valid in legal metrology)</p> <p>8. Battery symbol showing status of rechargeable battery (empty outline indicates battery is drained)</p> <p>9. GMP-compliant printing in progress (Signum 2 and 3 only)</p> <p>10. Weight unit of the value displayed</p> | <p>Signum 2 and 3 only:</p> <p>11. Numeric display; e.g., showing reference value</p> <p>Signum 2 and 3 only:</p> <p>12. Symbol indicating data transfer:</p> <ul style="list-style-type: none"> - Interface initialized - Flashes during data transfer <p>13. Symbol for product data memory</p> <p>14. In legal metrology, on equipment with $e \neq d$, the digit shown with a border is $d < e$.</p> <p>15. Auto or opt (Signum 2 and 3 only):</p> <ul style="list-style-type: none"> - Auto: Depending on the weight value, a reaction is triggered in the application - Opt: Reference sample value is being updated (optimized) automatically (Counting application) <p>16. Weight value or calculated value (main display)</p> <p>17. Application symbols for applications in Signum 2 and 3:</p> <ul style="list-style-type: none"> Application 1:
Counting Weighing in Percent Averaging (Animal Weighing) Application 2:
Checkweighing Classification Checkweighing: Batching to a Target Value | <p>Application 3:</p> <ul style="list-style-type: none"> Totalizing Net-total Formulation <p>Verified models only:</p> <p>18. The zero-setting symbol is displayed after the active scale or weighing platform has been zeroed (indicates that the deviation from zero is equal or less than 0.25 e)</p> <p>19. Plus or minus sign for the value displayed</p> <p>20. Busy symbol; indicates that an internal process is in progress</p> <p>Saving Data in Weighing Mode</p> <p>All of the application parameters saved (e.g., reference values) remain in memory and are still available after the Signum has been switched off</p> <ul style="list-style-type: none"> - you return to the originally selected application from a second one (e.g., when you switch from Averaging back to Counting, all parameters saved for Counting are available) |
|--|---|--|

Operating Design

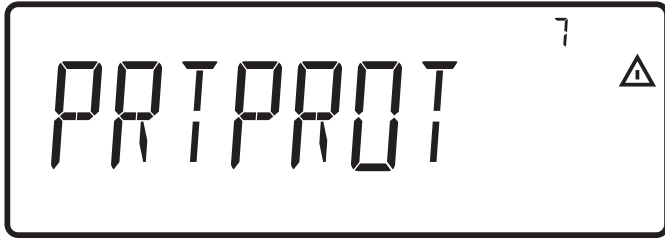

Display of menu settings: Text menu (example)



Display of menu settings: Numeric menu (example)

Configuration (Operating Menu)

The keys below the readout let you navigate the menu and define parameters for configuration.

Opening the Menu

Press the e key to switch the Signum off and then on again; while all segments are displayed, press the $\rightarrow T \leftarrow$ key briefly.

Navigating the Menu

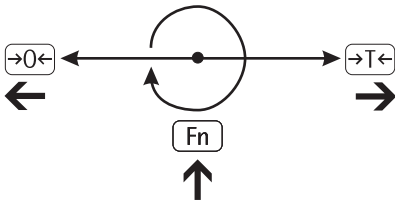

- $\rightarrow 0 \leftarrow$ Close the active submenu and return to the next higher menu level ("back")
- $\rightarrow T \leftarrow$
 - Press briefly: Select and save a menu item
 - Press and hold (> 2 seconds): Exit the menu
- Fn Show the next item on the same menu level (the display scrolls through all items in series)
- $\leftarrow E \rightarrow$ Print the menu settings starting from the current position, or print Info data

Alphanumeric Input in the Menu

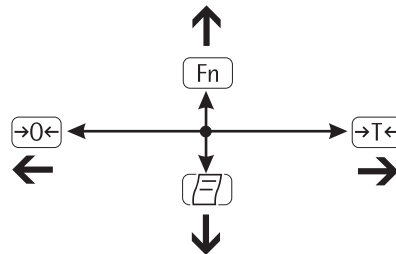

- $\rightarrow 0 \leftarrow$
 - Press briefly: Activate character to the left of the currently active character (when first character is active: exit the input mode without saving changes)
 - Press and hold (> 2 seconds): Exit the input mode without saving changes
- $\rightarrow T \leftarrow$
 - Press briefly: Confirm currently active character and move 1 position to the right (after the last character: save input)
 - Press and hold (> 2 seconds): Save current input and display the menu item
- Fn
 - Cursor in first position, no characters entered yet: Delete character(s) and enter 0
 - Change the displayed character; scroll forward (sequence: 0 through 9, decimal point, minus sign, A through Z, space)
- $\leftarrow E \rightarrow$
 - Cursor in first position, no characters entered yet: Delete entire string and enter a space
 - Change the displayed character; scroll backwards (sequence: Space, Z through A, minus sign, decimal point, 9 through 0)

Numeric input in Signum 3 operating menu:

Enter values (date and time, etc.) using the 10-key numeric keypad

Saving Menu Settings

The parameters selected in the operating menu remain saved after you switch off the Signum.

You can prevent unauthorized changes in operating menu settings by requiring password input for menu access.

Errors

- If a key is inactive, “----” or “No function” is displayed briefly (2 seconds) and an acoustic signal (double-beep) is emitted
- Temporary errors are displayed for 2 seconds in the measured value/result line (e.g., *INF 09*); fatal errors (e.g., *ERR 10 1*) can be cleared by switching the scale off and then on again.

Error codes are described in detail under “Error Codes” on page 91.

Data Output

Printer

You can connect two strip or label printers to Signum 1, 2 or 3, and have printouts generated at the press of a key or automatically. Printout formats are user-definable. You can also configure separate summarized printouts, and print a list of the active menu settings. See “Configuring Printouts” on page 82 for details.

Digital Input/Output Interface + Optional I/O

The digital I/O interface is supported by the Checkweighing and Classification applications.

Checkweighing

The output device has a number of control functions. Four data outputs transfer signals for “less than,” “equal to,” “greater” and “set.” You can define whether the outputs are always active or are activated only at stability, only within the checkweighing range, only within the checkweighing range at stability, or switched off.

Classification

Four data outputs transfer information on the class of the load (Class 1, 2, 3, 4 or 5) and indicate when the minimum load is exceeded (Set). You can define whether the outputs are always active, activated only at stability, or off. For details, see “Classification” on page 66.

COM Port

You can define a number of parameters for this SBI and SMA interface (print command, time-dependent autoprint, ID codes). See “Interface Port” on page 80 for details.

Backup

Application parameters (such as reference values) are saved when you change application programs or switch off the Signum. You can assign a password to prevent unauthorized users from changing settings in the “Device parameters” menu under:

```
SETUP  
└── PASSWORD
```

See also page 18.

Configuration

You can configure the Signum by selecting parameters in the operating menu. The parameters are combined in the following groups (this is the first menu level):

- Application parameters
- Fn key function
- Device parameters
- Device-specific information ("INFO")
- Language

When used in legal metrology, not all parameters can be accessed.

Factory-set parameters are identified by an "*" in the list starting on page 19.

You can choose from five languages for the display of information:

- German
- English (factory setting)
- English with U.S. date/time format
- French
- Italian
- Spanish

Printing parameter settings:

- Open the operating menu and press the  key

Scope of printout:
Depends on the active menu level

Setting the Language

Example: Selecting "U.S. Mode" for the language



Switch on the scale

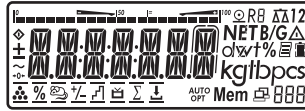

While all segments are lit, press the  key

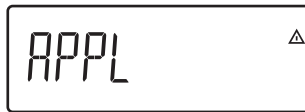

The first item in the main menu is shown: *APPL*



Switch to the *LANG.* menu item (press  repeatedly until *LANG.* is shown)



Select *LANG.* to open the submenu for setting the language

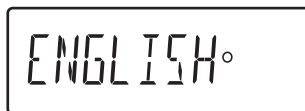

The currently active language setting is shown



Press  repeatedly until *U.S. MODE* is displayed



Confirm this menu item



Exit this menu level and configure other settings as desired, or













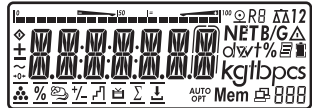







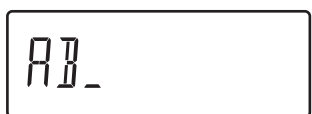



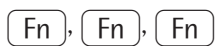
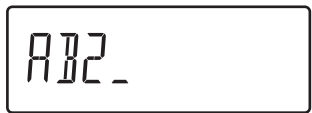



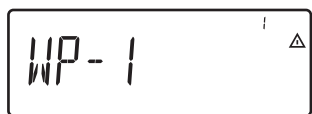





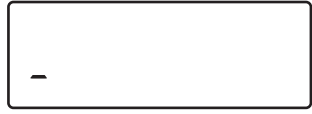

Exit the operating menu

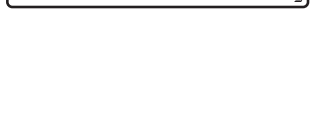

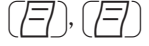
Configuring a Password

Example:

Assign a password (in this example, *AB2*) to protect the application program settings *APPL* and the device parameters *SETUP* from unauthorized changes

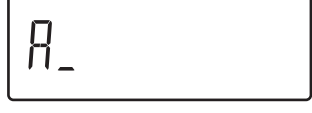
- | | | | |
|--|---|---|--|
| 
 | 1 Switch on the Signum | 
 | 9 Enter the second character using the  and  keys (in this example: <i>B</i>) |
| 
 | 2 While all segments are lit, press  . The first item in the main menu is shown: <i>APPL</i> | 
 | 10 Save the character |
| 
 | 3 Select the <i>SETUP</i> menu item (press  repeatedly until <i>SETUP</i> is displayed) | 
 | 11 Enter the third character using the  and  keys (in this example: <i>2</i>) |
| 
 | 4 Open the <i>SETUP</i> menu | 
 | 12 Save the password |
| 
 | 5 Select the <i>PASSWORD</i> menu item (press  repeatedly until <i>PASSWORD</i> is displayed) | 
 | 13 Exit this menu level to configure other menu settings, or |
| 
 | 6 Open the <i>PASSWORD</i> menu | 
 | 14 Exit the operating menu (press and hold the  key) |
| 
 | 7 Enter the first character using the  and  keys (in this example: <i>A</i> symbol is shown on the readout) |  | |
| 
 | 8 Save the character | | |

To delete a password:
 Overwrite the old password with the new password, or enter a space as the password and press  to confirm

Configuration

Operating Menu Overview

You can configure the Signum to meet individual requirements by entering user data and setting selected parameters in the operating menu.

Menu levels are identified by texts, and numeric codes identify the individual settings.

||||||||||| = Setting/function available in Signum 1 only
 ■■■■■■ = Setting/function available in Signum 2 and 3 only

1 st level display	2 nd level display	Function
Menu		
APPL		Select and configure application programs
	WEIGH.	Basic weighing function
	COUNT.	Counting
	NEUTR.M	Neutral measurement
	ANIM.WG	Averaging (animal weighing)
	CHECK.WG	Checkweighing
	CLSS.	Classification
	PERC.WG	Weighing in percent
	NET TOT	Net-total formulation
	TOTALIZ	Totalizing
FN-KEY		Define the function of the [Fn] key
	OFF	No function
	GROSSNET	Gross/net toggling (Signum 1 only)
	2UNIT	Show 2 nd weight unit
	RES 10	10-fold increased resolution (Signum 1 only)
	SQMIN	Show the minimum permissible sample quantity
SETUP		Adapt Signum to user requirements
	WP 1	Settings for weighing instrument on WP1
	COM 1	Settings for the RS-232 interface
	UNICOM	Settings for the optional second interface
	COMSPEC	Reference weigher connection: configure the A/D converter (optional)
	CTRL IO	Set the function of the universal input (control line)
	BARCODE	Set the bar code scanner function
	PRTPROT	Configure the printout
	UTILIT	Operating parameters
	TIME	Set the time
	DATE	Set the date
	PASSWORD	Enter a password to protect menu settings
	SQMIN	User options: <ul style="list-style-type: none"> - Display minimum permissible sample quantity - Include SQmin in GLP printout
INFO		View device-specific information (service date, serial number, etc.)
LANG		Select language for calibration, adjustment and GMP printouts
	DEUTSCH	German
	ENGLISH	English
	U.S. MODE	English with U.S. date/time format
	FRANC.	French
	ITAL.	Italian
	ESPANOL	Spanish

Operating Menu

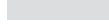
 = Setting/function available in Signum 1 only
 = Setting/function available in Signum 2 and Signum 3 only

* Factory setting

Menu

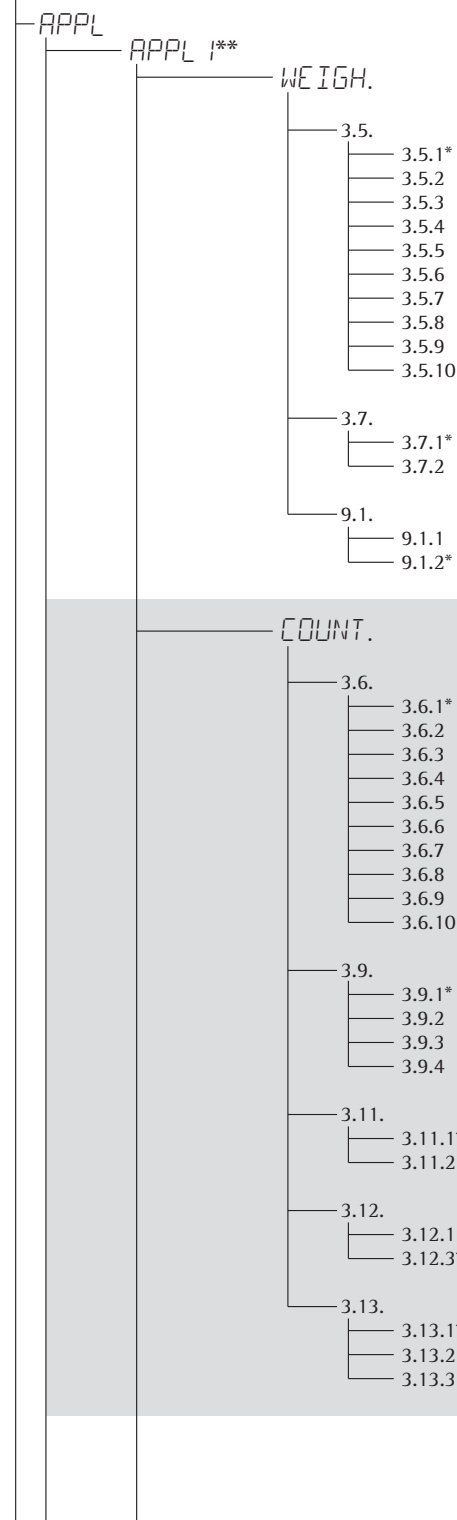

Application programs

Basic Weighing Function

Minimum load for automatic taring and automatic printing

- 1 digit
- 2 digits
- 5 digits
- 10 digits
- 20 digits
- 50 digits
- 100 digits
- 200 digits
- 500 digits
- 1000 digits

Automatic taring: first weight tared

- Off
- On

Factory settings for all application programs

- Yes
- No

Counting

Minimum load for initialization

- 1 digit
- 2 digits
- 5 digits
- 10 digits
- 20 digits
- 50 digits
- 100 digits
- 200 digits
- 500 digits
- 1000 digits

Resolution for calculation of reference value

- Display resolution
- Display resolution + 1 decimal place
- Display resolution + 2 decimal places
- Internal resolution

Parameter for saving weight ("storage parameter")

- At stability
- At increased stability

Reference sample updating ("APW update")

- Off
- Automatic

Reference weighing instrument

- No reference instrument selected
- Weighing platform WP 1
- Weighing platform WP 2

** Menu level used in Signum 3 only

Configuration

APPL			
APPL 1**			
NEUTR.M		Neutral Measurement	
3.6.		Minimum load for initialization	
	Numeric menu as for Counting		
3.9.		Resolution for calculation of reference value	
	3.9.1*	Display resolution	
	3.9.2	Display resolution + 1 decimal place	
	3.9.3	Display resolution + 2 decimal places	
	3.9.4	Internal resolution	
3.10.		Decimal places in displayed result	
	3.10.1 *	None	
	3.10.2	1 decimal place	
	3.10.3	2 decimal places	
	3.10.4	3 decimal places	
3.11.		Parameter for saving weight	
	3.11.1*	At stability	
	3.11.2	At increased stability	
3.13.		Reference weighing instrument	
	3.13.1*	Off	
	3.13.2	To weighing platform WP1	
	3.13.3	To weighing platform WP2	
ANIM.WG		Averaging (Animal Weighing)	
3.6.		Minimum load for automatic start	
	Numeric menu as for Counting		
3.18.		Start of averaging routine	
	3.18.1*	Manual	
	3.18.2	Automatic	
3.19.		Averaging	
	3.19.1	0.1 % of the animal/object	
	3.19.2*	0.2% of the animal/object	
	3.19.3	0.5 % of the animal/object	
	3.19.4	1% of the animal/object	
	3.19.5	2% of the animal/object	
	3.19.6	5% of the animal/object	
	3.19.7	10% of the animal/object	
	3.19.8	20% of the animal/object	
	3.19.9	50% of the animal/object	
	3.19.10	100 % of the animal/object	
3.20.		Automatic printout of results	
	3.20.1*	Off	
	3.20.2	On	
3.21.		Static display of result after load removed	
	3.21.1*	Display is static until unload threshold reached	
	3.21.2	Display is static until [CF] is pressed	

* Factory setting

** Menu level used in Signum 3 only

APPL			
	APPL 1**	PERC.WG	Weighing in Percent
		3.6.	Minimum load for saving initialization
		Numeric menu as for Counting	
		3.9.	Resolution for calculation of reference value
		3.9.1*	Display resolution
		3.9.2	Display resolution + 1 decimal place
		3.9.3	Display resolution + 2 decimal places
		3.9.4	Internal resolution
		3.10.	Decimal places in displayed result
		3.10.1*	None
		3.10.2	1 decimal place
		3.10.3	2 decimal places
		3.10.4	3 decimal places
		3.11.	Parameter for saving weight
		3.11.1*	At stability
		3.11.2	At increased stability
		3.13.	Reference weighing instrument
		3.13.1*	Off
		3.13.2	To weighing platform WP1
		3.13.3	To weighing platform WP2
		3.15.	Display of calculated value
		3.15.1*	Residue
		3.15.2	Loss
	APPL 2**	CHECK.WG	Checkweighing
		4.2.	Checkweighing range
		4.2.1*	30 to 170%
		4.2.2	10% to infinity
		4.3.	Activate control line for "Set" as:
		4.3.1*	"Set" output
		4.3.2	Ready to operate (for process control systems)
		4.4.	Activation of outputs
		4.4.1	Off
		4.4.2	Always active
		4.4.3	Active at stability
		4.4.4*	Active within checkweighing range
		4.4.5	Active at stability within the checkweighing range
		4.5. Parameter input	
		4.5.1*	Min, max, target
		4.5.2	Only target with percent limits
		4.6.	Automatic printing
		4.6.1*	Off
		4.6.2	On
		4.6.3	Only values within tolerance
		4.6.4	Only values outside tolerance
		4.7.	Checkweighing toward zero
		4.7.1*	Off
		4.7.2	On
	OFF		Disabled

* Factory setting

** Menu level used in Signum 3 only

Configuration

APPL			
APPL 2**			
	CLASS.	Classification	
	3.6.	Minimum load for initialization and defining the class 1 lower limit	
	3.6.1*	1 digit	
	3.6.2	2 digits	
	3.6.3	5 digits	
	3.6.4	10 digits	
	3.6.5	20 digits	
	3.6.6	50 digits	
	3.6.7	100 digits	
	3.6.8	200 digits	
	3.6.9	500 digits	
	3.6.10	1000 digits	
	4.3.	Activate control line for "Set" as:	
	4.3.1*	"Set" output	
	4.3.2	Ready to operate (for process control systems)	
	4.7.	Activation of outputs	
	4.7.1	Off	
	4.7.2	Always active	
	4.7.3*	Active at stability	
	4.8.	Number of classes	
	4.8.1*	3 classes	
	4.8.2	5 classes	
	4.9.	Parameter input	
	4.9.1*	Weight values	
	4.9.2	Percentage	
	4.10.	Automatic printing	
	4.10.1*	Off	
	4.10.2	On	
APPL 3**			
	NET TOT	Net-total Formulation (Second Tare Memory)	
	3.6.	Minimum load for automatically saving/transferring values	
	Numeric menu as for Counting		
	3.17.	Printout when value is saved in totalizing memory	
	3.17.1	Automatic printout of results off	
	3.17.2*	Generate printout with complete standard configuration each time OK is pressed	
	3.17.3	Generate printout with complete standard configuration only once when OK is pressed	
	TOTALIZ	Totalizing	
	3.6.	Minimum load for automatically saving/transferring values	
	Numeric menu as for Counting		
	3.16.	Values saved automatically	
	3.16.1*	Off	
	3.16.2	On	
	3.17.	Printout when value is saved in totalizing memory	
	3.17.1	Automatic printout of results off	
	3.17.2*	Individual of transaction by pressing OK	
	3.17.3	Print components of transaction by pressing OK	
	3.22.	Source of data for values saved automatically	
	3.22.1*	Application 1	
	3.22.2	Application 2	
	3.23.	Value(s) to be saved	
	3.23.1*	Net	
	3.23.2	Calculated	
	3.23.3	Net and calculated	
OFF		Disabled	

* Factory setting

** Menu level used in Signum 3 only

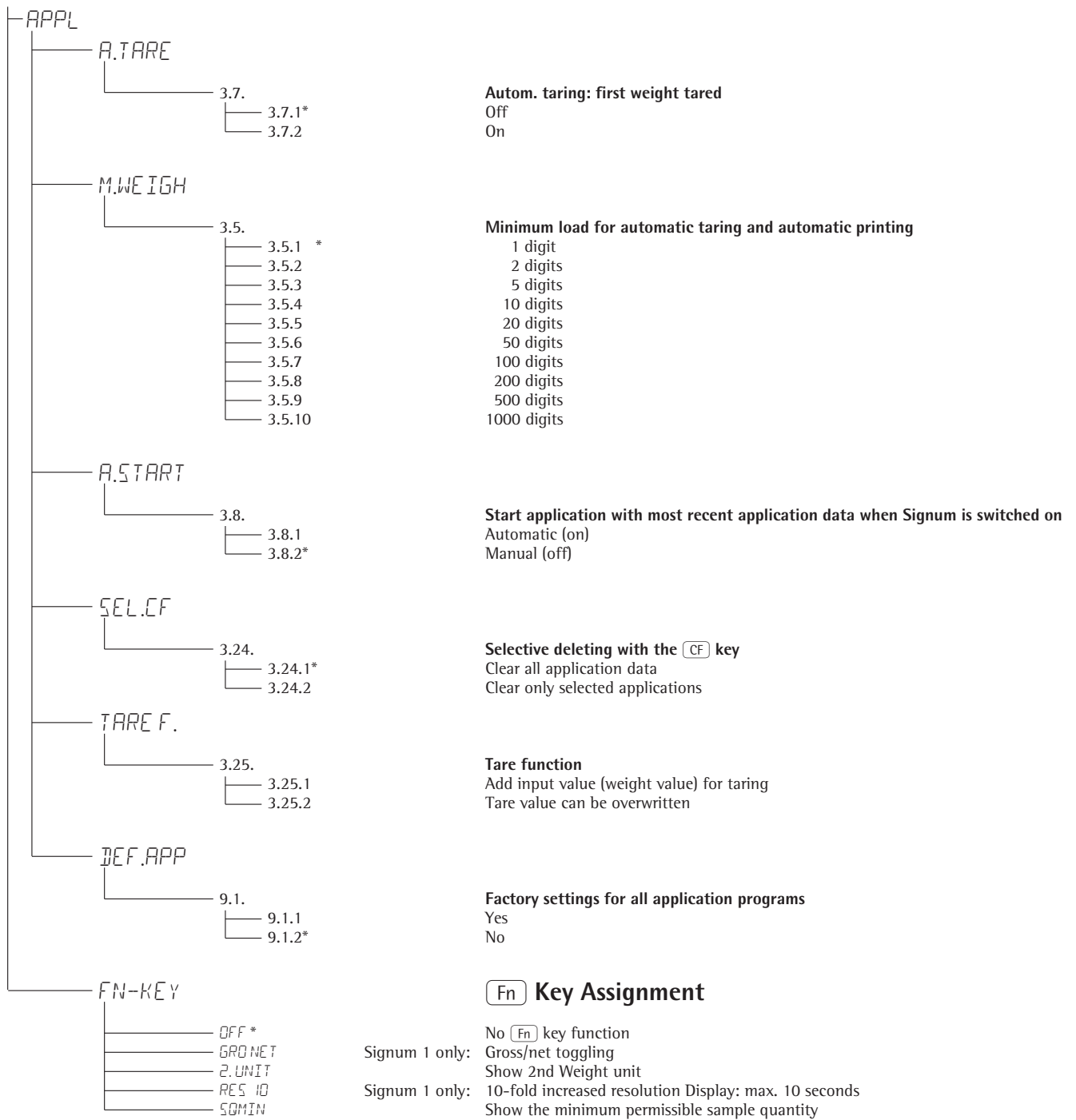

* Factory setting

Configuration

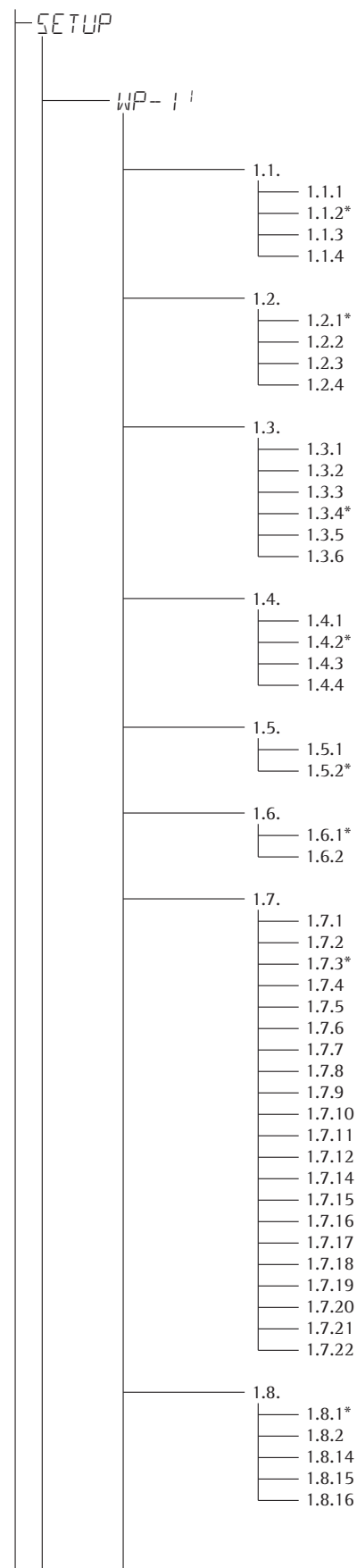

Device Parameters

Password prompt displayed if a password is configured

Weighing platform 1

(Display designation of this menu level: !)

Adapt weighing instrument to ambient conditions (adapt filter)

Very stable conditions
Stable conditions
Unstable conditions
Very unstable conditions

Application filter

Final readout
Filling mode
Low filtering
Without filtering

Stability range

¼ digit
½ digit
1 digit¹⁾
2 digits¹⁾
4 digits¹⁾
8 digits¹⁾

Stability symbol delay

No delay
Short delay
Average delay
Long delay

Taring¹⁾

Without stability
After stability

Auto zero

On
Off

Weight Unit 1²⁾

Grams / o
Grams / g
Kilograms / kg
Carats / ct¹⁾
Pounds / lb¹⁾
Ounces / oz¹⁾
Troy ounces / ozt¹⁾
Hong Kong taels / tlh¹⁾
Singapore taels / tlc¹⁾
Taiwanese taels / tlt¹⁾
Grains / GN¹⁾
Pennyweights / dwt¹⁾
Parts per pound / lb¹⁾
Chinese taels / tlc¹⁾
Mommies / mom¹⁾
Austrian carats / k¹⁾
Tola / tol¹⁾
Baht / bat¹⁾
Mesghal / MS¹⁾
Tons / t
Pounds:ounces (lb:oz)

Display accuracy 1

All digits
Reduced by 1 decimal place for load change
10-fold increased resolution
Resolution increased by 2 scale intervals (e.g., 5 g to 1 g)
Resolution increased by 1 scale interval
(e.g., from 2 g to 1 g or from 10 g to 5 g)

¹⁾ Not available on instruments verified for use in legal metrology

²⁾ Depends on weighing platform model

* Factory setting

SETUP WP-11

- 1.9.
 - 1.9.1*
 - 1.9.3
 - 1.9.4
 - 1.9.8
 - 1.9.9
 - 1.9.10
- 1.10.
 - 1.10.1
 - 1.10.2*
- 1.11.
 - 1.11.1
 - 1.11.2*
- 1.12.
 - 1.12.1*
 - 1.12.2
 - 1.12.3
- 1.13.
 - 1.13.1*
 - 1.13.2
 - 1.13.3
- 1.15.
 - 1.15.1*
 - 1.15.2
- 1.16.
 - 1.16.1*
 - 1.16.2²⁾
- 1.17.
 - 1.17.1
 - 1.17.2*
 - 1.17.3
- 1.18.
 - 1.18.1
- 3.1.
 - 3.1.1
 - 3.1.2
 - 3.1.3*
 - 3.1.4
 - 3.1.5
 - 3.1.6
 - 3.1.7
 - 3.1.8
 - 3.1.9
 - 3.1.10
 - 3.1.11
 - 3.1.12
 - 3.1.14
 - 3.1.15
 - 3.1.16
 - 3.1.17
 - 3.1.18
 - 3.1.19
 - 3.1.20
 - 3.1.21
 - 3.1.22
- 3.2.
 - 3.2.1*
 - 3.2.2
 - 3.2.14
 - 3.2.15
 - 3.2.16
- 3.3.
- 3.4.
- 9.1.
 - 9.1.1
 - 9.1.2*

Calibration and adjustment

External calibration/adjustment; default weight
 External calibration/adjustment; weight can be selected under menu item 1.18.1
 Internal calibration/adjustment (models with built-in motorized calibration weight only)
 Set preload
 Clear preload
 No function when you press the  key

Calibration/adjustment sequence

Calibration with automatic adjustment
 Calibration with adjustment triggered manually

Zero-setting range

1 percent/max. cap.
 2 percent/max.cap.

Initial zero-setting range

Factory setting (depends on model)
 2 percent/max. cap.
 5 percent/max.cap. (setting depends on model)

Tare/zero at power on

On
 Off, load previous tare value
 Only zero at power on

Calibration prompt

Off
 Calibration prompt ($\Delta\Delta$) flashes on the display

External calibration/adjustment¹⁾

Accessible
 Blocked

Calibration weight unit

Grams
 Kilograms
 Pounds¹⁾

Enter calibration weight
 External user-defined weight (enter value; e.g.: 10,000 kg)

Weight unit 2³⁾

Grams / o
 Grams / g
 Kilograms / kg
 Carats / ct¹⁾
 Pounds / lb¹⁾
 Ounces / oz¹⁾
 Troy ounces / ozt¹⁾
 Hong Kong taels / tlh¹⁾
 Singapore taels / tls¹⁾
 Taiwanese taels / tlt¹⁾
 Grains / GN¹⁾
 Pennyweights / dwt¹⁾
 Parts per pound / lb¹⁾
 Chinese taels / tlc¹⁾
 Mommes / mom¹⁾
 Austrian carats / k¹⁾
 Tola / tol¹⁾
 Baht / bat¹⁾
 Mesghal / MS¹⁾
 Tons / t
 Pounds:ounces (lb:oz)

Display accuracy 2

All digits
 Reduced by 1 decimal place for load change
 10-fold increased resolution
 Resolution increased by 2 scale intervals (e.g., 5 g to 1 g)
 Resolution increased by 1 scale interval (e.g., from 2 g to 1 g or from 10 g to 5 g)

Weight unit 3³⁾ (settings as for 3.1, "Weight unit 2")

Display accuracy³⁾ (settings as for 3.2, "Display accuracy 2")

Restore factory settings in WP1 numeric menu

Yes
 No

¹⁾ = Not available on instruments verified for use in legal metrology
²⁾ = Factory setting on instrument verified for use in legal metrology
³⁾ = Menu depends on weighing platform model
 * Factory setting

Configuration

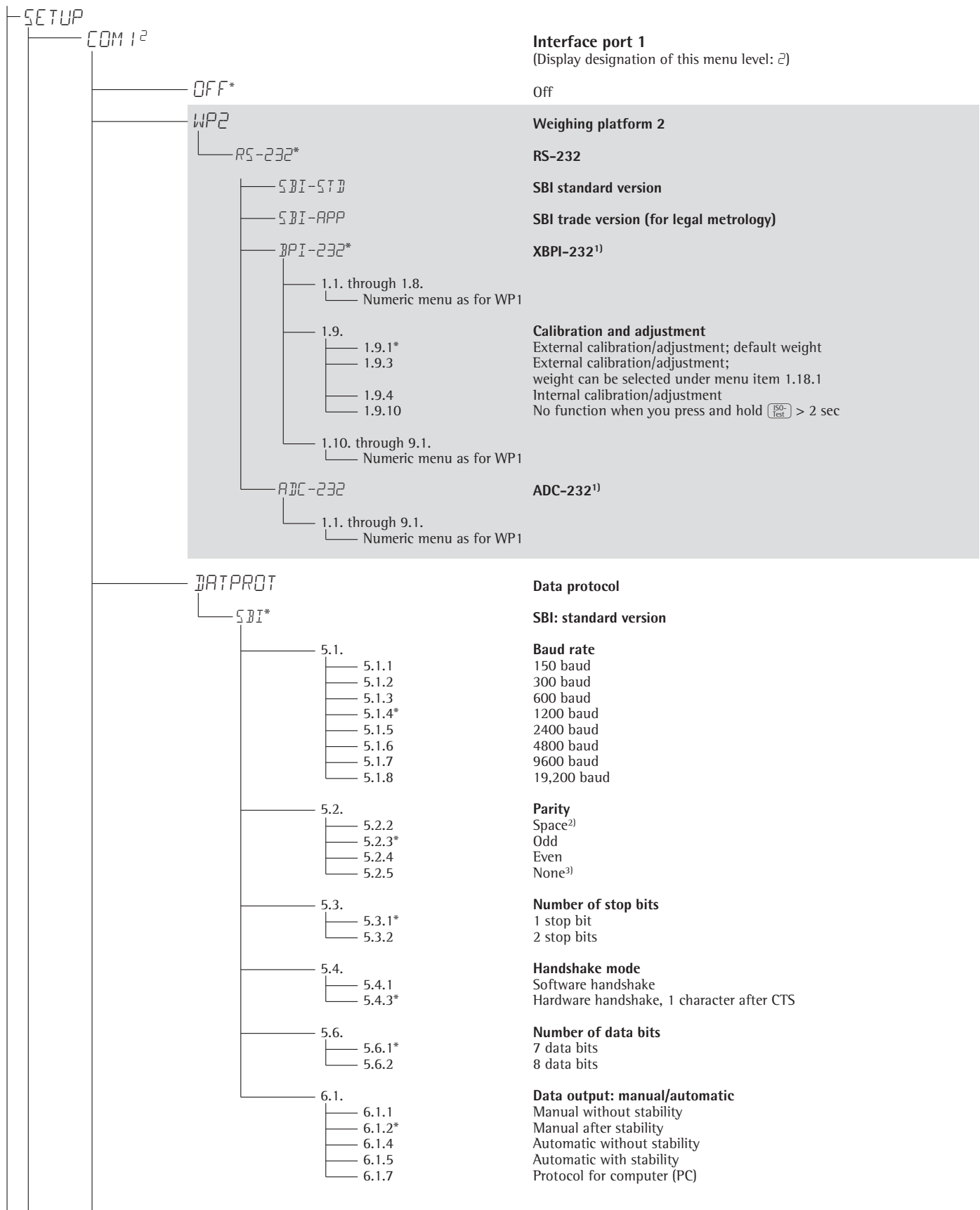

¹⁾ Menu depends on weighing platform model

³⁾ not with setting 5.6.1 (7 bits)

* Factory setting

²⁾ not with setting 5.6.2 (8 bits)

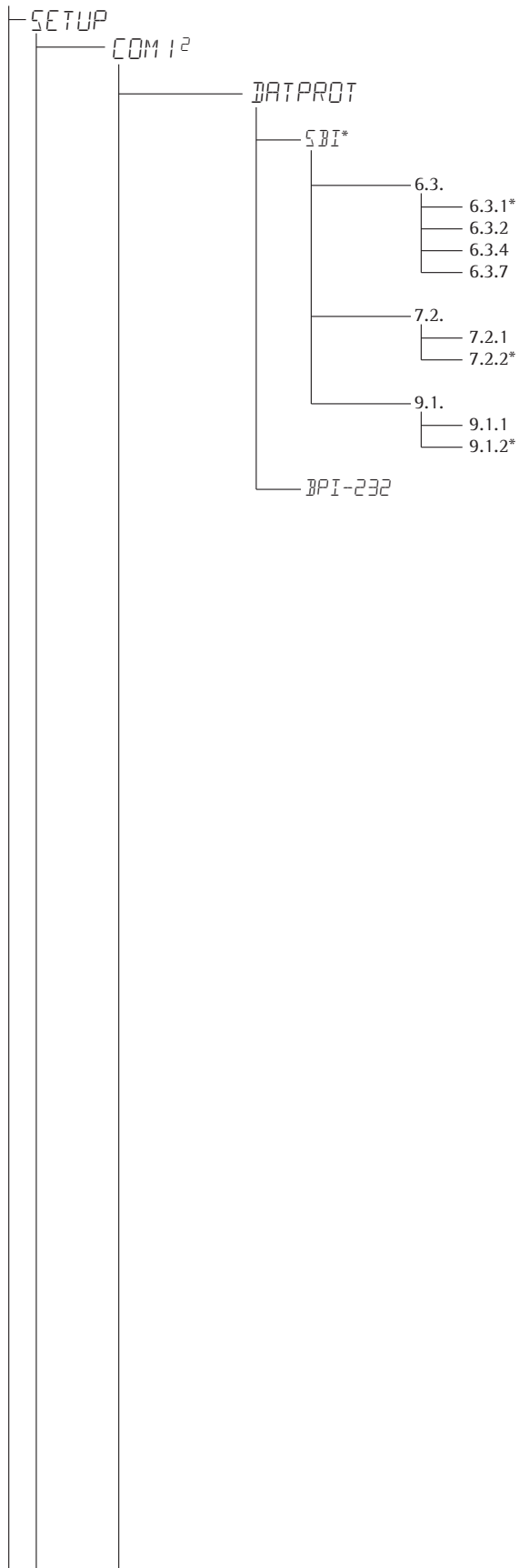

Time-dependent automatic data output

- 1 display update
- 2 display updates
- 10 display updates
- 100 display updates

Data output: line format for printout

- For raw data: 16 characters
- For other applications: 22 characters

Restore factory settings in numeric menu COM1: SBI

- Yes
- No

XBPI-232

* Factory setting

Configuration

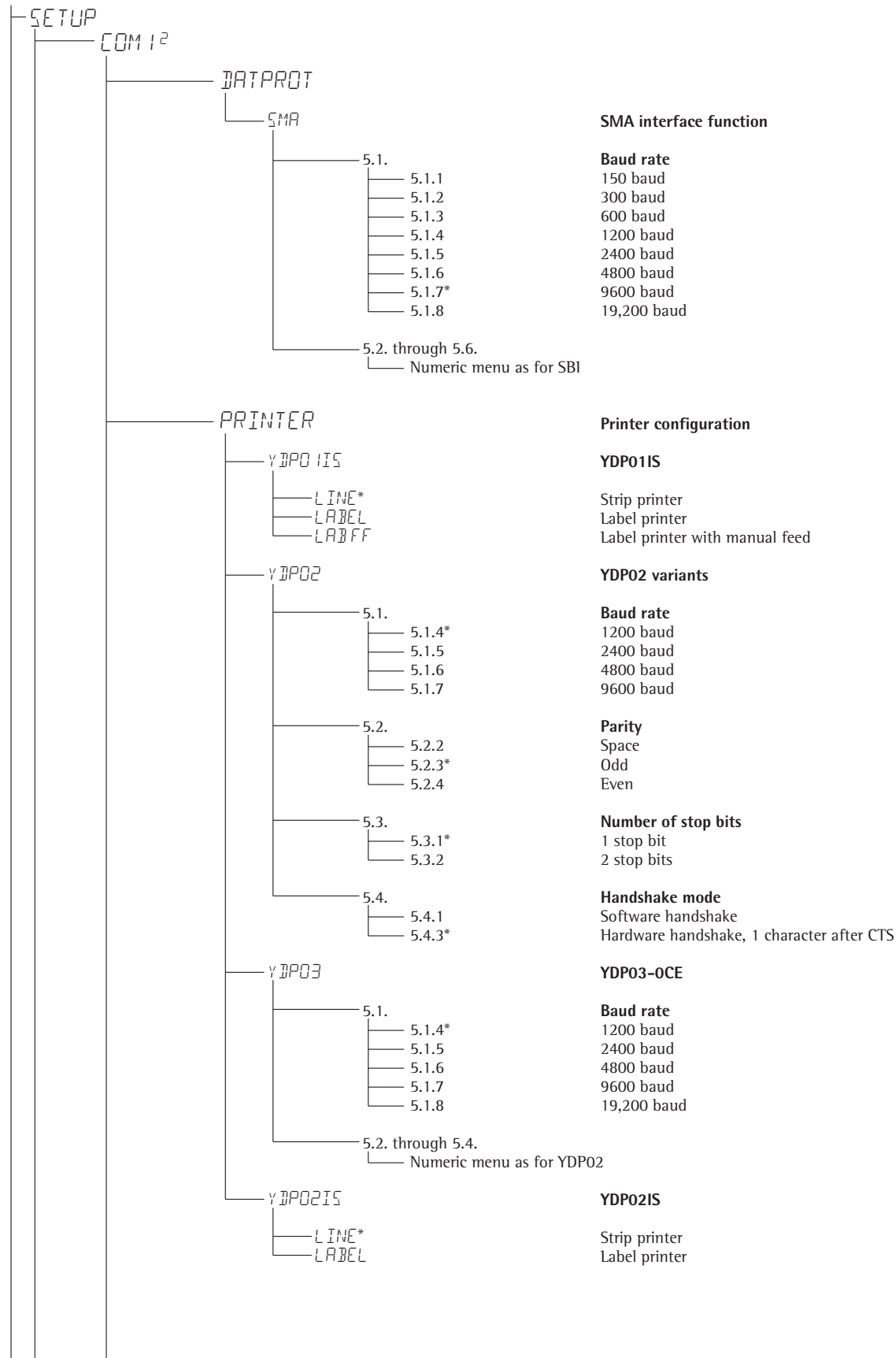

* Factory setting

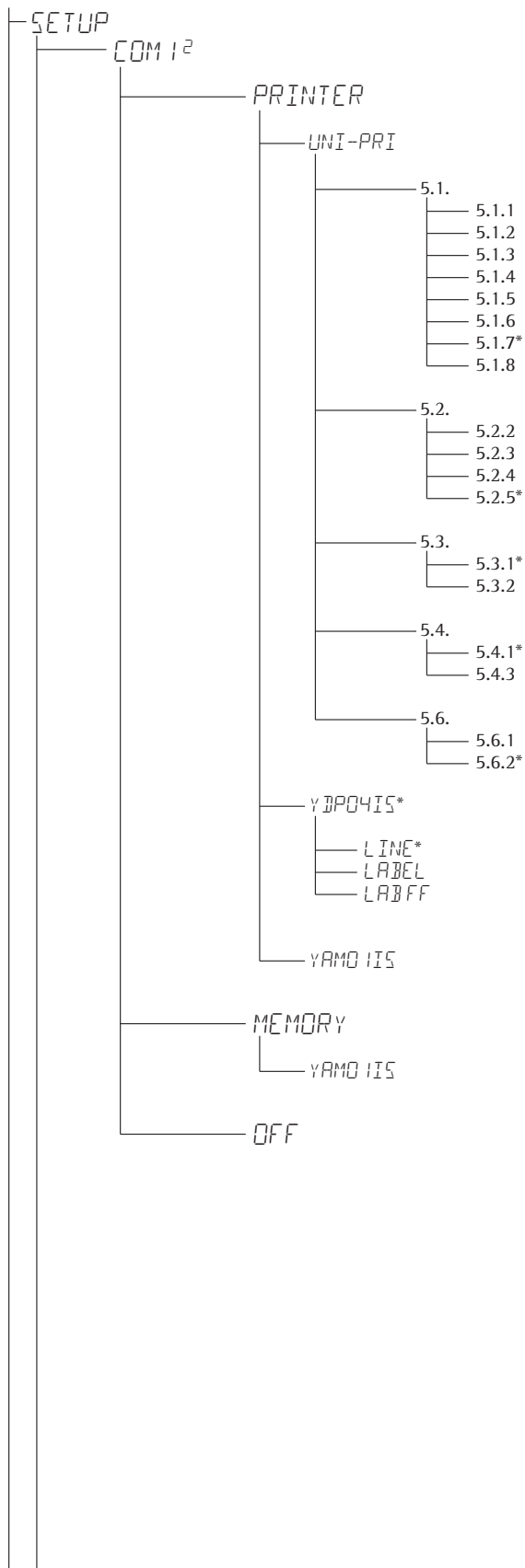

Universal interface

Baud rate
 150 baud
 300 baud
 600 baud
 1200 baud
 2400 baud
 4800 baud
 9600 baud
 19,200 baud

Parity
 Space¹⁾
 Odd
 Even
 None²⁾

Number of stop bits
 1 stop bit
 2 stop bits

Handshake mode
 Software handshake
 Hardware handshake, 1 character after CTS

Number of data bits
 7 data bits
 8 data bits

YDP04IS

Strip printer
 Label printer
 Label printer with manual feed

YAM01IS as electronic memory for print data

Verifiable data memory

YAM01IS external data memory

Off (disabled)

¹⁾ not with setting 5.6.2 (8 bit)

²⁾ not with setting 5.6.1 (7 bits)

* Factory setting

Configuration

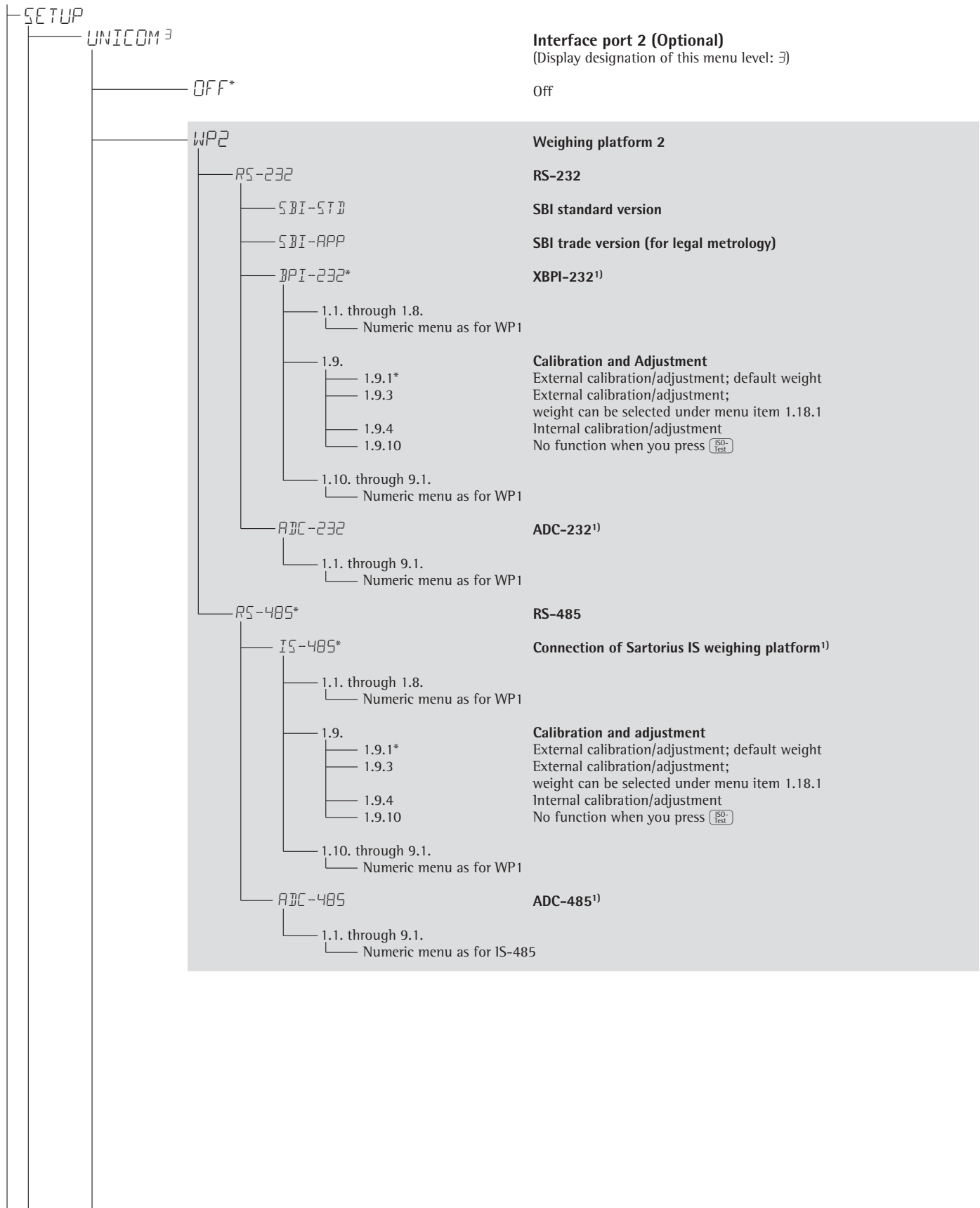

* Factory setting

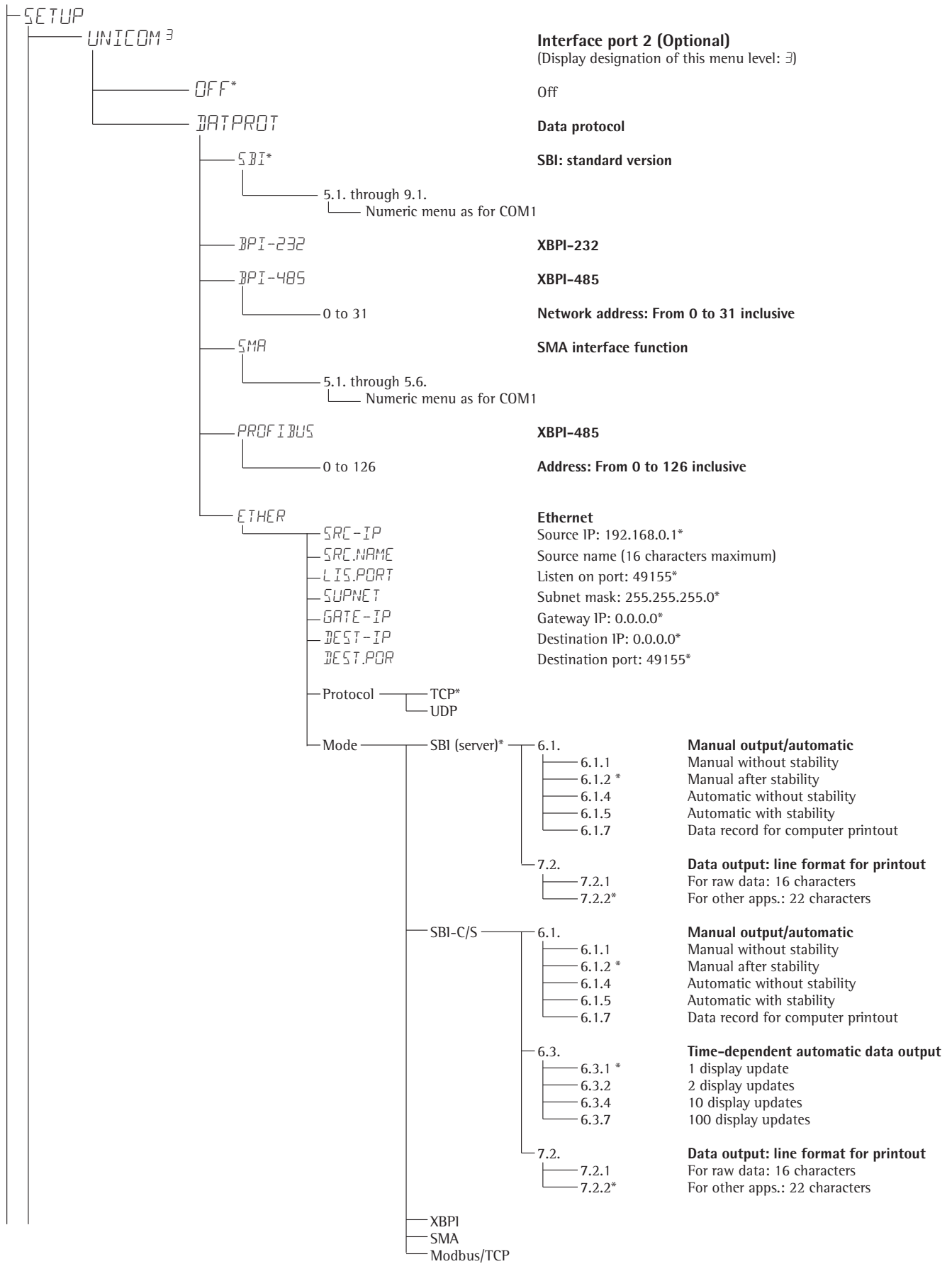

* Factory setting

Configuration

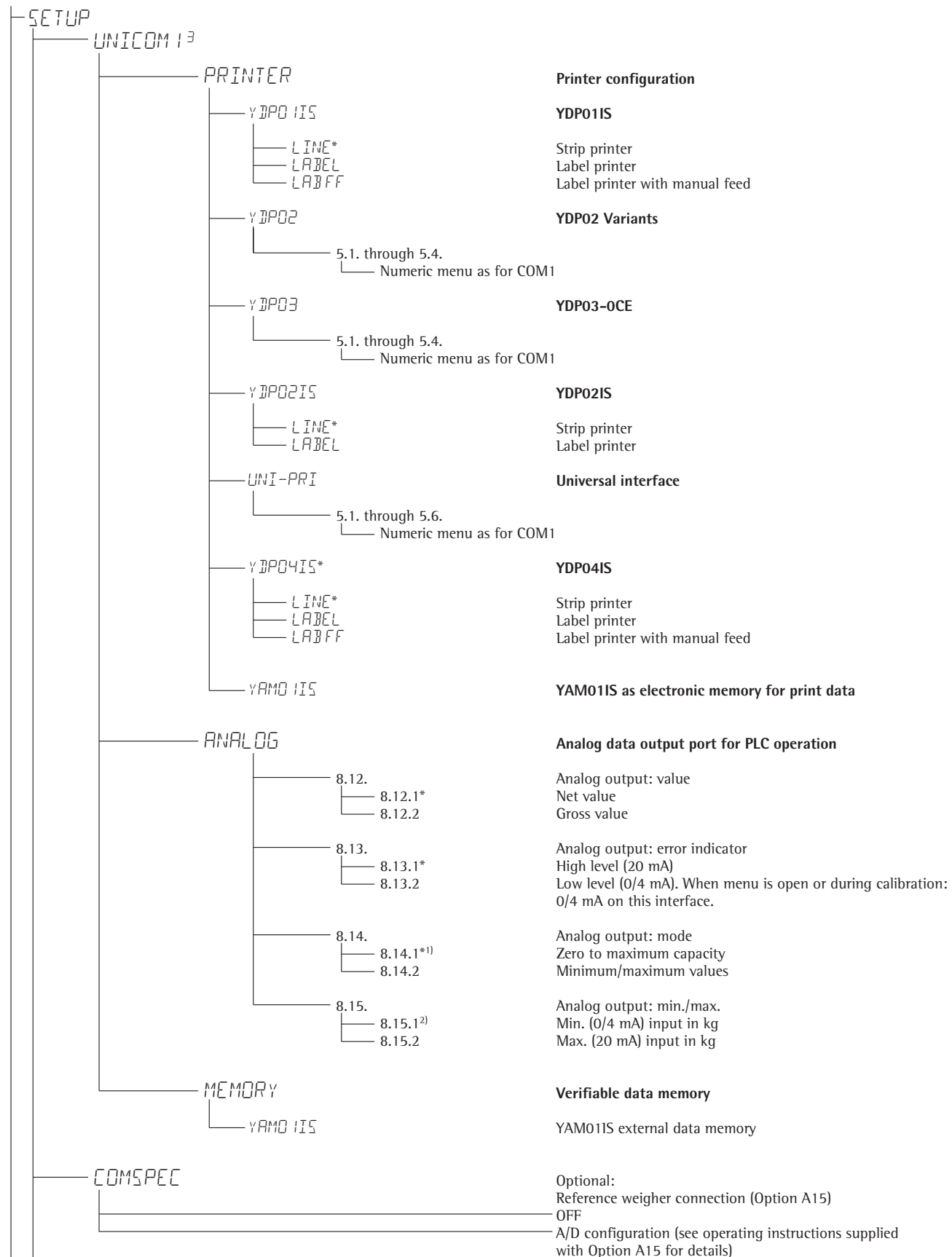

¹⁾ When setting 8.14.1 is active, analog data output only works for XBPI weighing instruments

²⁾ not with setting 8.14.1

* Factory setting

Configuration

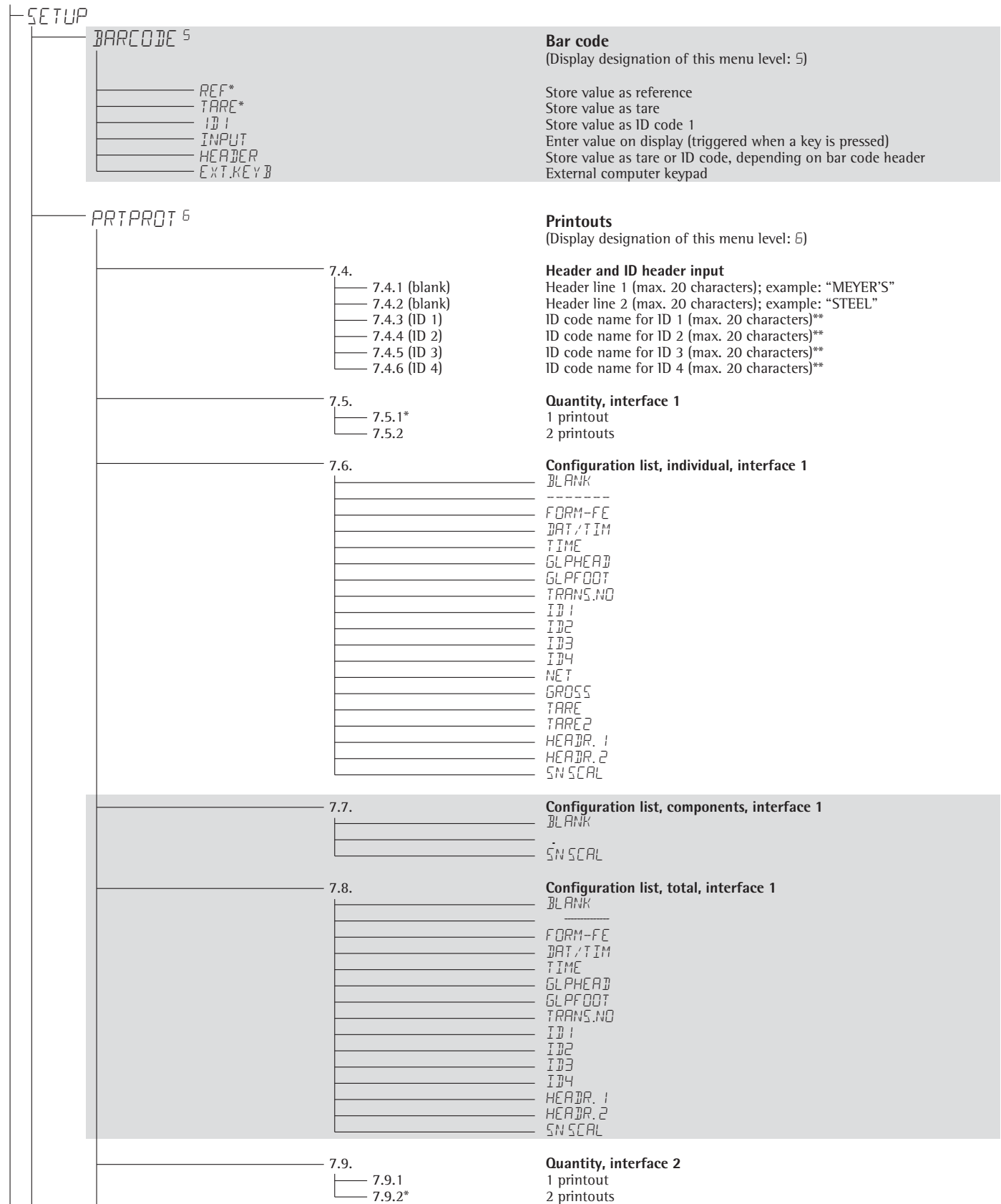

** Signum 3 only
 * Factory setting

— SETUP

PRTPROT 6

7.10.		Configuration list, individual, interface 2 BLANK ----- FORM-FE DAT/TIM TIME GLPHEAD GLPFOOT TRANS.NO ID1 ID2 ID3 ID4 NET GROSS TARE TARE2 HEADR.1 HEADR.2 SN SCAL
7.11.		Config. list, component, interface 2 BLANK ... SN SCAL
7.12.		Configuration list, total, interface 2 BLANK ----- FORM-FE DAT/TIM TIME GLPHEAD GLPFOOT TRANS.NO ID1 ID2 ID3 ID4 HEADR.1 HEADR.2 SN SCAL
7.13.	7.13.1* 7.13.3	GMP record (optional on Signum 1) GMP off GMP on for multiple results
7.14.	7.14.1* 7.14.2	Date with/without time Date block includes time on printout Time not printed
7.15.	7.15.1* 7.15.2	Automatic print after stability Auto print at stability: off Auto print at stability: on
7.16.	7.16.1* 7.16.2	Flex Print Flex Print: no Flex Print: yes
7.17.	7.17.1* 7.17.2	Decimal separator Period (decimal point) Comma
9.1.	9.1.1 9.1.2*	Restore factory settings in numeric menu for printout data protocol Yes No

* Factory setting

Configuration

SETUP

UTILIT ¹⁾

8.3.

- 8.3.1*
- 8.3.2
- 8.3.3
- 8.3.4
- 8.3.5
- 8.3.6
- 8.3.7
- 8.3.8
- 8.3.9
- 8.3.10
- 8.3.11
- 8.3.12
- 8.3.13
- 8.3.14
- 8.3.15
- 8.3.16
- 8.3.17
- 8.3.18
- 8.3.19

8.7.

- 8.7.1
- 8.7.2*

8.8.

- 8.8.1*
- 8.8.2
- 8.8.3

8.9.

- 8.9.1*
- 8.9.2
- 8.9.3

8.11.

- 8.11.1*
- 8.11.2

8.12.

- 8.12.1*
- 8.12.2

9.1.

- 9.1.1
- 9.1.2*

Operation

(Display designation of this menu level: 7)

Keys

All available	
All blocked	
Numeric keypad	Signum 3 only
Toggle weighing platform	Signum 2 and 3 only
Zero	
Tare	
FN	
isoTEST	
Print	
x10	Signum 2 and 3 only
Toggle gross/net	Signum 2 and 3 only
CF	Signum 3 and 3 only
Ref	Signum 3 and 3 only
OK	Signum 3 and 3 only
Toggle	Signum 2 and 3 only
Info	Signum 2 and 3 only
D	Signum 3 only
ID	Signum 3 only
Mem	Signum 3 only

Automatic shutoff of display and control unit

Automatic shutoff acc. to menu item 8.9.
No automatic shutoff

Display lighting

On
Off
Automatic shutoff acc. to menu item 8.9.

Timer mode

After 1 + 1 minute not in use
(after 1 min.: warning²⁾ displayed for 1 minute)
After 2 + 2 minutes not in use
(after 2 min.: warning²⁾ displayed for 2 minutes)
After 5 + 5 minutes not in use
(after 5 min.: warning²⁾ displayed for 5 minutes)

Main scale: first platform displayed on start-up

Weighing platform WP1
Weighing platform WP2

Show geographical data before calibration

No
Yes

Restore factory settings in numeric operating menu

Yes
No

¹⁾ More than one can be selected

²⁾ Warning: the $\Delta\Delta$ symbol and weighing platform numbers 1 and 2 flash simultaneously

* Factory setting

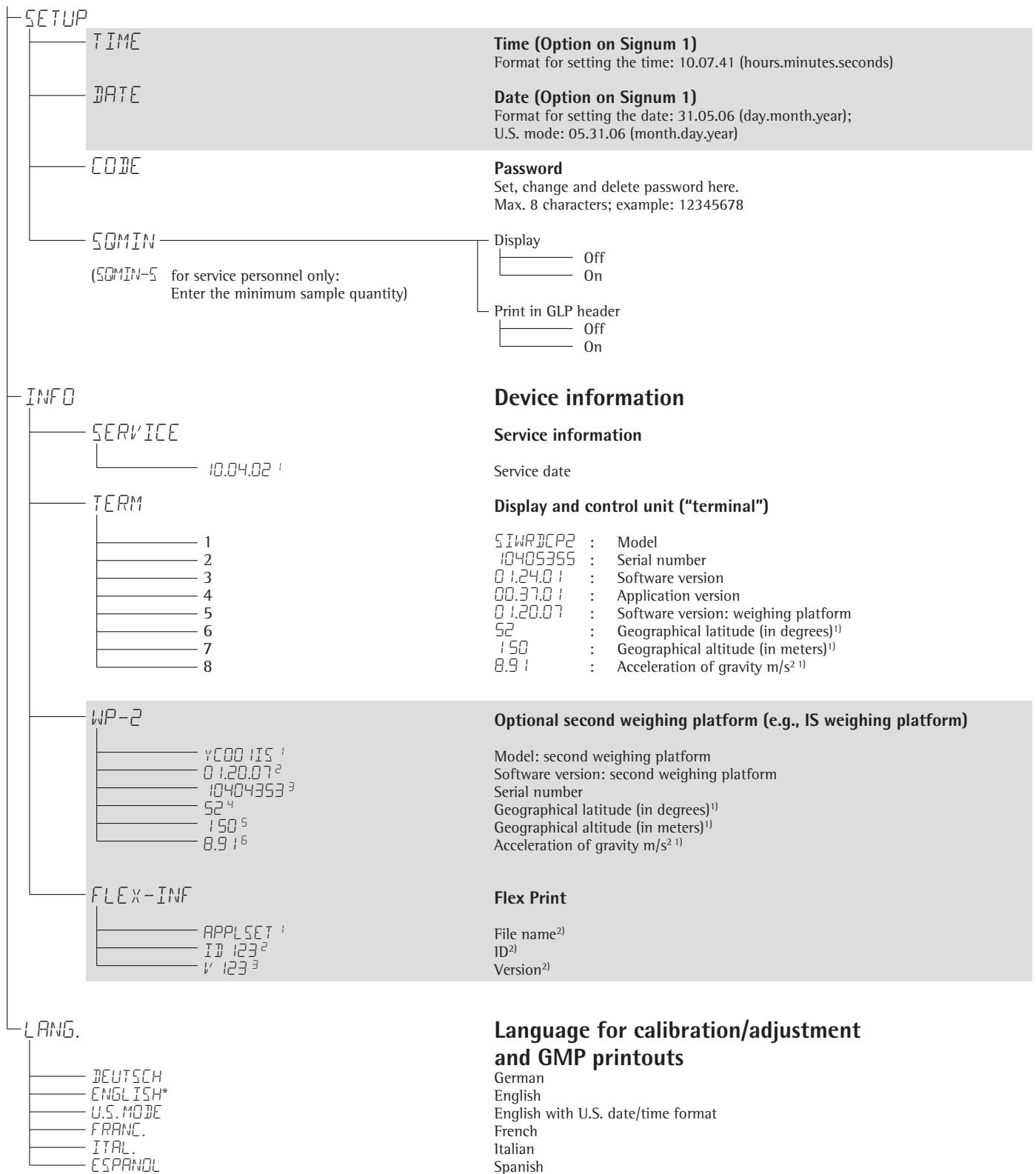

¹⁾ Output: either latitude and altitude or acceleration of gravity (depends on the input before verification)

²⁾ These three parameters are shown for each file loaded

* Factory setting

Operation

Basic Weighing Function

Weighing $\Delta\Delta$

The basic weighing function is always accessible and can be used alone or in combination with application programs, such as Counting, Checkweighing, Weighing in Percent, etc.

Features

- Zero the scale $\rightarrow 0 \leftarrow$
 - Store the weight on the platform as tare by pressing $\rightarrow T \leftarrow$
 - Use the numeric keys to enter a tare weight (press $\rightarrow T \leftarrow$ to save)
- Signum 2 and 3 only:
- Use a bar code scanner to enter tare weight
 - Tare container weight automatically
 - Delete tare values by entering $\square 0$ (press $\rightarrow T \leftarrow$ to save)

Signum 1 only:

- Press Fn to toggle the display between:
 - Gross and net values, or
 - 10-fold increased resolution (displayed for 5 seconds max.)

Signum 2 and 3 only:

- Press B/G to toggle the display between:
 - Gross and net values, or
 - Normal and 10-fold increased resolution (displayed for 5 seconds max.)

Define the Fn key function in the Setup menu, under: *FN-KEY*

- Weigh with two weighing platforms

Signum 3 only:

- Individual ID codes for weight values
- Print weight values:
 - Manually, by pressing E
 - Automatically (see "Interface Port")
 - With GMP-compliant format (see "Interface Port")
- Restore factory settings by selecting the menu setting:
 - APPL*: (applications)
 - WEIGH*: (basic weighing)
 - 9.1*. (factory settings)

Automatic Taring

The first weight on the scale that exceeds the preset minimum load is stored in the tare memory at stability. The values for subsequent loads are stored as weight values. The scale returns to the initial state when the load is less than 50% of the minimum load. Operating menu setting:
APPL: (application)
WEIGH: (basic weighing)
3.7. (autotare first weight)

Minimum Load

To tare container weights automatically, you need to set a minimum load in the Setup menu, under:
APPL: (application)
WEIGH: (basic weighing)
3.5. (Min. load for autotaring)

You can choose from the following 10 levels, defined in scale intervals (digits):

- 1 digit (no minimum load)
- 2 digits
- 5 digits
- 10 digits
- 20 digits
- 50 digits
- 100 digits
- 200 digits
- 500 digits
- 1000 digits

If the scale interval (d) is 1000 g, for example, and the minimum load is set to 1000 digits (=1000 scale intervals), a load of at least 1000 g is required for autotaring.

Automatic Printing

The first weight value that exceeds the minimum load is printed. Operating menu setting:
SETUP: (application)
PRTPROT: (printout)
7.15. (autoprint at stability)

Signum 2 and 3 only:

Weighing with Two Weighing Platforms

Press the AVA key to toggle the display between weighing platforms. Specify one of the two platforms as the main scale under:
SETUP: (application)
UTILIT: (additional functions)
8.11. (main scale)

The display shows the readout from the main scale when you switch on the Signum. Press AVA to toggle the readout between platforms.

Signum 2 and 3 only:

Entering Tare Weight using a Bar Code Scanner

You can enter the tare value of a container using a bar code scanner. To do this, the "Store value as tare" (*TARE*) menu item must be selected under "Setup > Barcode" in the operating menu. In this case, the value is stored as the tare automatically, without pressing the Tare key. To view the contents of the tare memory, press the Info key.

Device Parameters

Keys

The keypad can be blocked. Operating menu setting:

SETUP:

UTILIT: (additional functions)

8.3. (keypad: blocking keys)

You can choose from the following options:

- *8.3.1*. All keys accessible
- *8.3.2*. All keys blocked except UC and SETUP
- *8.3.3*. All alphanumeric keys blocked
- *8.3.4*. - *8.3.19*. One specified key blocked (see the menu under "Configuration" for options)

Display

You can have the display backlighting shut off automatically when not in use. Operating menu setting:

SETUP

UTILIT

8.8. (display lighting)

Automatic Shutoff

Operating menu setting:

SETUP

UTILIT

8.7. (automatic shut off of display and control unit)

Timer Mode

There are three timer settings for this function: two, four and ten minutes.

Operating menu setting:

SETUP:

UTILIT:

8.9. (timer mode)

Example with Signum 1:

Switch on the Signum, zero the scale, tare the container weight, place sample in container, toggle display to gross weight or to second weight unit, print results.

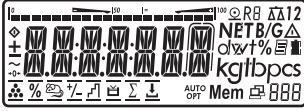

1 Switch on the scale

All display segments are shown for about 1 second (self-test)

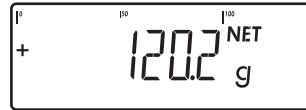

Display with tared scale and filled container

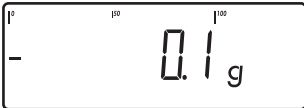

Display with no load on scale

Fn (Signum 1)

6 Toggle display; depending configuration, display shows

B/G (Signum 2 and 3)



gross weight (in this example, 50 g for container + 120.2 g substrate) or



2 Zero the scale



Display with no load on scale

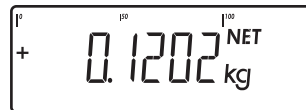

display in 2nd weight unit (in this example, kg) or

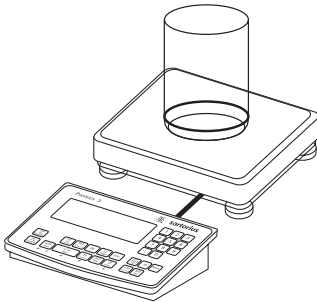

3 Place container on weighing instrument



display with 10-fold increased resolution

Fn

7 Return to previous display (if 10-fold resolution is shown, display returns automatically after 5 seconds)

x10 Signum 2 and 3

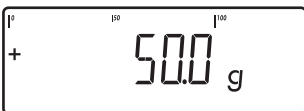
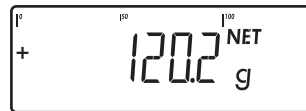

Container weight is displayed



8 Print results



4 Tare the scale

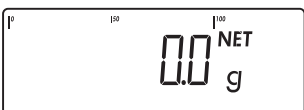

Display (NET) when tared with container

ACE HARDWARE		
GOETTINGEN		
24.02.2002		15:10

G#	+	170.2 g
T	+	50.0 g
N	+	120.2 g

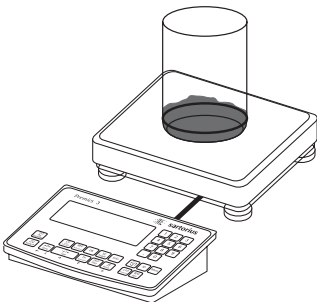

5 Fill the container (in this example, 120.2 g)

Operation

Example with Signum 1:

Tare the scale by placing a container on the weighing platform



- 1 Switch on the scale.
The automatic self-test runs. When the weight readout is shown, the scale is ready to operate and automatically set to zero. Press $\rightarrow 0 \leftarrow$ to reset the un-loaded weighing platform to zero at any time.

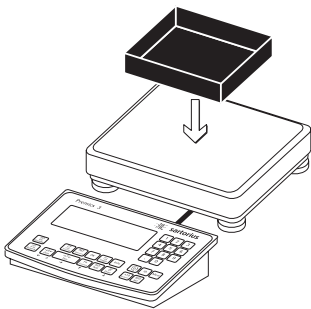

- 2 Place empty container on the platform.



- 3 Tare the scale.
Note: If the automatic tare function is active, you do not need to press $\rightarrow T \leftarrow$ to tare the scale; the tare weight is saved automatically when you place the container on the platform.



Wait until a zero value is displayed together with the NET symbol.

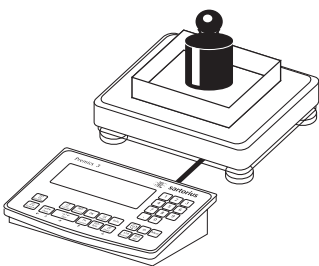

- 4 Place sample on the platform

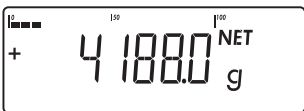

Wait until the weight unit is shown (stability symbol) and read off the weight value.

Example with Signum 3:

Weigh with numerical input of the tare weight, Print the result



- 1 Switch on the scale.
The automatic self-test runs. When the weight readout is shown, the scale is ready to operate and automatically set to zero. Press $\rightarrow 0 \leftarrow$ to reset the unloaded weighing platform to zero at any time.

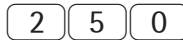

- 2 Enter the known tare weight via the keypad (in this example, 250 g).

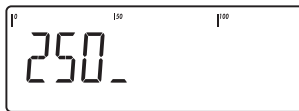

- 3 Save the tare weight.

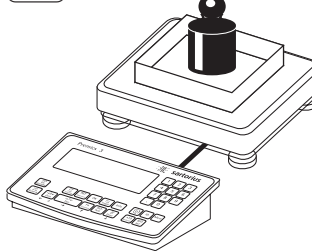

- 4 Place the sample (in this example, 2 kg) in its container on the scale.



Read the result



- 5 Toggle the display from net to gross weight values. The display shows the gross weight (in this example, 250 g for the container plus 2000 g for the sample).

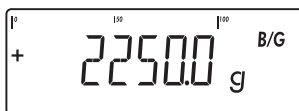

- 6 Return to the previous display.

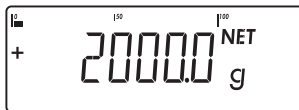

- 7 Print the results.

G#	+	2.250 kg
T	+	0.000 kg
PT2	+	0.250 kg
N	+	2.000 kg

Example with Signum 3:

Weigh with variable tare values, print the results and delete the tare values



- 1 Switch on the scale.
The automatic self-test runs. When the weight readout is shown, the scale is ready to operate and automatically set to zero. Press $\rightarrow 0 \leftarrow$ to reset the unloaded weighing platform to zero at any time.



Read the net weight

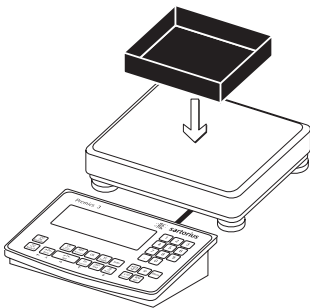

- 2 Place empty container on the platform



- 7 Print the results.

G#	+	6.433	kg
T	+	4.183	kg
PT2	+	0.250	kg
N	+	2.000	kg



- 3 Tare the scale
Note: If the automatic tare function is active, you do not need to press $\rightarrow T \leftarrow$ to tare the scale; the tare weight is saved automatically when you place the container on the platform.



- 8 Clear the tare memory: Use the keypad to enter a zero ("0").

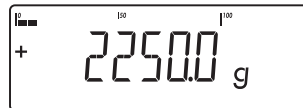

- 9 Save the value (0) entered (tare values are cleared; the display shows the gross value).



Wait until a zero value is displayed together with the NET symbol.



- 10 Print the result.

G#	+	6.433	kg
T	+	0.000	kg
N	+	6.433	kg

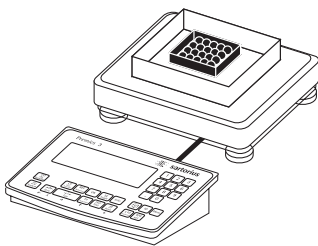

- 4 Place the sample in its packaging (second tare value) in the container.

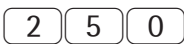

- 5 Enter the known weight of the packaging, in the active weight unit, via the keypad (in this example, 250 g).



- 6 Save the package weight you entered (the two tare values are added together).

Operation

Calibration and Adjustment

Purpose

Perform calibration to determine the difference between the value displayed and the actual weight on the platform. Calibration does not entail making any changes within the weighing instrument.

Perform adjustment to eliminate any difference determined, or to reduce it to a level that is within the applicable tolerance limits.

Using Verified Scales as Legal Measuring Instruments in the EU*:

The type-approval certificate for verification applies only to non-automatic weighing instruments; For automatic operation with or without auxiliary measuring devices, you must comply with the regulations applicable to the place of installation.

- Before using your balance as a legal measuring instrument, you must adjust it at the place of installation using the built-in motorized calibration weight. For details, see “Internal Calibration” in this chapter.
- The temperature range (°C) indicated on the verification label may not be exceeded during operation.

For service technicians only:

External calibration for verified scales of accuracy class II or III

- The external calibration function is blocked on scales used in legal metrology (legal-for-trade applications).
- This seal must be removed before external calibration/adjustment can be performed.

In this case, verification will become null and void and the scale will have to be re-verified.

Using Verified Scales as Legal Measuring Instruments in the EU*:

- Before you use your scale as a legal measuring instrument, internal calibration must be performed at the place of installation.

SIWR | SIWA models: Configuration for Use in Legal Metrology

To configure the scale for use in legal metrology, adjust the switch on the back of the display and control unit. The switch is covered by a protective cap.

Position:

- Switch on the right: For use in legal metrology
- Switch on the left: External calibration/adjustment accessible

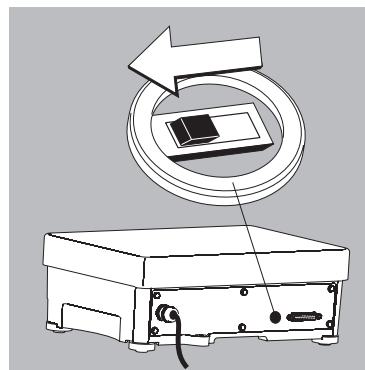

Features

Which of the following features are available for configuration in the Setup menu depends on the connected scale:

- External calibration/adjustment blocked in verified weighing instruments
- External calibration/adjustment with the default weight value or standard weight (not available on verified instruments). Configure under:
`SETUP`
`WP-1`
`1.9.:` (calibration and adjustment)
- Specify the weight for external calibration/adjustment:
`SETUP`
`WP-1`
`1.18.:` (enter calibration weight)
- Internal adjustment for IS weighing platforms (configure under:
`COM 1:` or `UNICOM: WP2`)

- Block the  key to prevent use of the two functions described above (1.9.10):

`SETUP`

`WP-1`

`1.9.:` (calibration and adjustment)

- Calibrate first; then adjust automatically or manually (not on verified weighing instruments):

`SETUP`

`WP-1`

`1.10.:` (calibration/adjustment sequence)

- Flashing $\Delta\Delta$ symbol as adjustment prompt. If more than one weighing platform is connected, the platform number is also displayed:

`SETUP`

`WP-1`

`1.15.:` (calibration prompt)

- Block or release external calibration/adjustment (not available on scales verified for use in legal metrology):

`SETUP`

`WP-1`

`1.16.:` (external calibration)

SIWR | SIWA Models: Geographical Data

- Altitude and latitude or gravitational acceleration displayed after `CAL` is shown when the Signum is switched on, if these values have been entered.

`SETUP`

`UTILIT`

`0.12.:` (show geographical data before calibration)

For each of these parameters, the term is displayed first (`ALTITUDE`, `LATITUDE` or `GRAVITY`) for 1 second, after which the corresponding value is displayed continuously until you press).

* Including the Signatories of the Agreement on the European Economic Area

Internal Calibration

SIWS models:

Verified scale or scale equipped with Option E7

In the operating menu under setup:

WP- 1: 1.9., the "Internal calibration" option (MENU CODE 1.9.4) must be set.

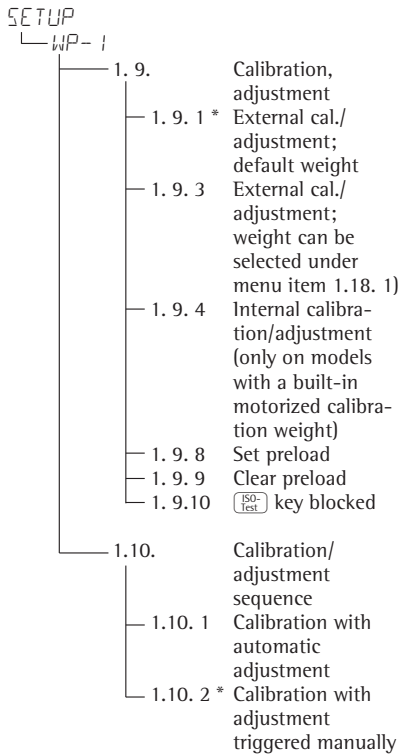

* = Factory settings



The built-in motorized calibration weight is applied and removed automatically for internal calibration.

The adjustment procedure is as follows:

- Select calibration/adjustment:
Press the  key
- > The built-in weight is applied automatically
- > The scale is adjusted
- > If menu code 1.10.1 is selected under *SETUP: WP- 1: 1.10.*, the scale is adjusted automatically
- > If menu code 1.10.2 is selected under *SETUP: WP- 1: 1.10.*, the internal calibration routine can be stopped at this point, before adjustment is carried out
- > The built-in calibration weight is unloaded from the weighing system
- > ISO/GMP-compliant printout:
see page 81



Setting the Preload

Notes on Settings

- ⚠ The preload can be set only when the menu access switch is open.
- The "set preload" function must be assigned to the  key (menu item 1.9.8).
- ⚠ After setting the preload, close the menu access switch and reset the  key to its previous function (e.g., external calibration/adjustment with user-defined weights) under menu item 1.9.

Clearing the Preload

Notes on Settings

- ⚠ The preload can be cleared only when the menu access switch is open.
- The "clear preload" function must be assigned to the  key (menu item 1.9.9).
- ⚠ After clearing the preload, close the menu access switch and reset the  key to its previous function (e.g., external calibration/adjustment with user-defined weights) under menu item 1.9.

Operation

Preparation

- Switch on the scale: Press **ON**
- While all segments are lit, press the **←T→** key
- Select the Setup menu: Press **Fn** repeatedly until **SETUP** is displayed
- Open the Setup menu: Press the **←T→** key
- Select weighing platform 1, “**WP 1**”: Press the **←T→** key, or
- Select interface 1, “**COM 1**” or interface 2, “**COM 2**” (depending on the interface used): Press the **Fn** key
Select weighing platform 2, “**WP 2**”: Press the **←T→** key

SETUP		
WP-1		
1.9.		Calibration and Adjustment
1.9.1*		Ext. calibration/adjustment; default weight
1.9.3		Ext. calibration/adjustment; weight can be selected under menu item 1.18.1
1.9.4		Internal calibration/adjustment (models with built-in motorized calibration weight only)
1.9.8		Set preload
1.9.9		Clear preload
1.9.10		No function when you press ISO-Test
1.10.		Calibration/Adjustment Sequence
1.10.1		Calibration with automatic adjustment
1.10.2*		Calibration with adjustment triggered manually
1.11.		Zero-setting Range
1.11.1		1 percent/max. cap.
1.11.2*		2 percent/max.cap.
1.12.		Initial Zero-setting Range
1.12.1*		Factory setting (depends on model)
1.12.2		2 percent/max. cap.
1.12.3		5 percent/max.cap. (setting depends on model)
1.13.		Tare/zero at Power On
1.13.1*		On
1.13.2		Off, load previous tare value
1.13.3		Only zero at power on
1.15.		Calibration Prompt
1.15.1*		Off
1.15.2		Calibration prompt (ΔΔ) flashes on the display
1.16.		External Calibration ¹⁾
1.16.1*		Accessible
1.16.2 ²⁾		Blocked
1.17.		Calibration weight unit
1.17.1		Grams
1.17.2*		Kilograms
1.17.4		Pounds ¹⁾
1.18.		Enter Calibration Weight
1.18.1		External user-defined weight (enter value; e.g.: 10,000 g)

- Save settings and exit operating menu: **→0←** key (repeatedly)

¹⁾ = Setting cannot be changed on verified models

²⁾ = Factory setting on verified models

* Factory setting

Example:

External calibration and manual adjustment with default weights (with factory settings for weighing parameters)



1 Zero the scale



2 Start calibration (e.g., after calibration prompt: flashing *WP* symbol).



EXT.DEF is shown for two seconds.

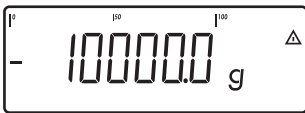

The prompt for the calibration weight is shown (in this example, 10 kg).

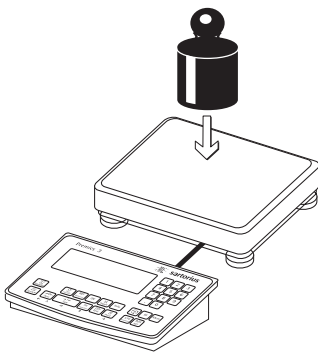

3 Place calibration weight on the weighing platform.

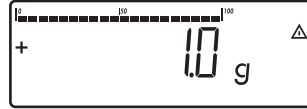
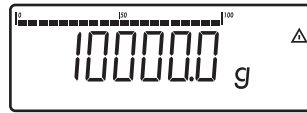

The difference between measured value and the true mass is shown, plus or minus sign.

```
Ext. calibration
Nom. + 10000 g
Diff. + 1 g
```

Printout is generated, if adjustment was not performed and the procedure is canceled by pressing →0←.



4 Start adjustment (or cancel calibration/adjustment by pressing →0←).

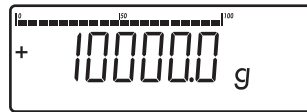

After adjustment, the calibration weight value is displayed.

```
-----
24.10.2006      10:15
Typ             SIWR
Ser.no.        12345678
Vers.          1.0103.11.2
BVers.         01-26-02
-----
```

A GMP-compliant printout is generated

```
Ext. calibration
Nom. + 100000 g
Diff. + 10 g
Ext. adjustment
Diff. + 0.0 g
-----
```

```
24.10.2006      10:15
Name:
```

```
24.10.2006      10:15
```

Operation

SQmin Function

Purpose

To display the allowable minimum sample quantity "SQmin" in accordance with the United States Pharmacopoeia (USP). According to USP guidelines, the uncertainty of measurement may not exceed 0.1 % of the sample quantity when substances are weighed with the highest degree of accuracy for volume determination. This additional function ensures that weighing results lie within defined tolerance limits corresponding to the requirements of your quality assurance system.

Features

- The service technician will determine the required minimum sample quantity based on your quality assurance requirements at the location where the scale is set up, and save this value in the scale. This setting cannot be changed by the user.
Once this programming is concluded, the service technician will prepare a "Test in Accordance with the USP" certificate that documents the measurements and the minimum sample quantity for the scale. When you use the SQmin function, you can be sure that the weight results will correspond to the specifications on the certificate and, therefore, USP guidelines.
- Displaying the minimum sample quantity:
The value is shown in the text line for 4 seconds after the **[Fn]** key is pressed.
- If the minimum sample quantity has not been reached, the **⚠** symbol is shown on the readout during weighing, and the weight values are marked with an exclamation point ("!") on the printout.
- GMP header: The minimum sample quantity entered for SQmin can be included on the printout.

Factory settings:

Display: SQmin Off

Print in GMP header: OFF

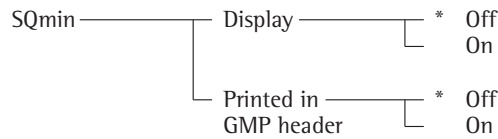

* = factory settings

See also "Operating Menu Overview" in the chapter entitled "Configuration."









- Press **[→T←]** to save your settings and **[→0←]** (repeatedly) to exit the operating menu.

Example

Determining sample weights while monitoring the minimum sample quantity (in this example, SQmin = 100 g)

Settings (changes in the factory settings required for this example):

Setup: SQmin: Display

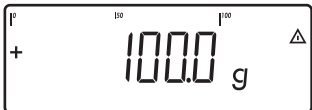
Step	Key (or action)	Display/printout
1 Switch on the scale and configure settings as indicated above		
2 Place the container for the sample on the scale and tare		
3 Measure the weight of a sample (in this example: minimum sample quantity not reached)	Place sample on scale	
4 Print weight		N + 90.0 !
5 Measure the weight of another sample (in this example: minimum sample quantity exceeded)	Place sample on scale	
6 Print weight		N + 110.0 g
7 Show value of minimum sample quantity for 4 seconds		
8 Weigh other samples as desired		

Operation

Data ID Codes

Signum 3 only

You can assign codes (such as product name, batch number, etc.) for identification of measured values on printouts.

Features

- Assign up to four ID codes.
- Assign both a name and a value for each ID code.
- The name is left-justified and the value is right-justified on the printout. If the entire code is too long for one line, additional lines are printed.
- Enter ID code names in the operating menu, under:
SETUP
PRTPROT: 7.4.
Enter up to 20 characters for the ID code name. No more than 11 characters are displayed during input; all 20 characters are printed.
- Enter up to 40 characters for the value of the ID code. Press the ID key to activate the input mode.
- You can delete characters from the ID code by pressing the **CF** key.
- If both the name and value fields are empty, no ID code is printed.
- In the Setup program, you can configure when and whether ID codes are printed (see "Configuring Printouts" on page for operating menu settings).

Factory settings for the ID code names:

ID1: *ID1*
ID2: *ID2*
ID3: *ID3*
ID4: *ID4*

Factory settings for the ID code values:

No default values set.

Example with Signum 3:

Enter ID code names.

Enter "Batch no." and "Cust." as names for ID codes 1 and 2.



1 Switch on the scale

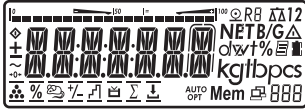

2 While all segments are lit, press the $\rightarrow T \leftarrow$ key

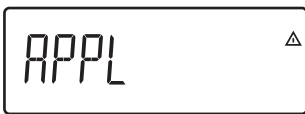

The first item in the main menu is shown: *APPL*



3 Select the Setup menu to access scale configuration functions (press Fn repeatedly until Setup is displayed)



4 Open the Setup menu



5 Select the *PRTPROT* menu item to access ID code settings (press Fn repeatedly until *PRTPROT* is displayed)



6 Select the menu item for header and ID code settings



7 Press Fn repeatedly until 7.4.1 is displayed.



8 Press $\rightarrow T \leftarrow$ key to activate alphanumeric input



9 1. Used the \leftarrow and Fn keys to enter code (in this example: the first character is "[")



10 Save the character



11 Proceed as described above to enter subsequent characters.

After entering the last character, press $\rightarrow T \leftarrow$ to save the code.

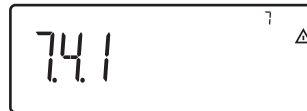

12 Exit the active submenu and configure other settings, or

13 Press and hold $\rightarrow T \leftarrow$ to exit the operating menu



Example with Signum 3:

Enter ID code values.

Enter "123" as the value for ID code 1.

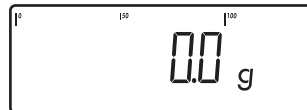

1 Activate ID input.

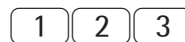

2 Enter value for ID code 1 (in this example: 123).



3 Press OK to conclude input.

Application Programs

Applications 1 through 3: Overview

	Signum 1	Signum 2	Signum 3
Keypad	6 keys	14 keys	17 keys plus numeric keypad
Display	14-segment	14-segment plus application symbols	14-segment plus application symbols

Application

Basic weighing	X	X	X
Averaging (animal weighing)		X	X
Send print job/data record to peripheral device	X	X	X
Print labels		X	X
Connectivity for 2nd weighing instrument		X	X
Counting		X	X
Totalizing		X	X
Checkweighing		X	X
Batching/Counting to target value		X	X
Product data memory			X

Function

Zero-setting	X	X	X
Taring	X	X	X
Date and time		X	X
Internal battery (rechargeable)	optional	optional	optional
ID codes (4 codes, 40 characters each)			X
Bar code		optional	optional

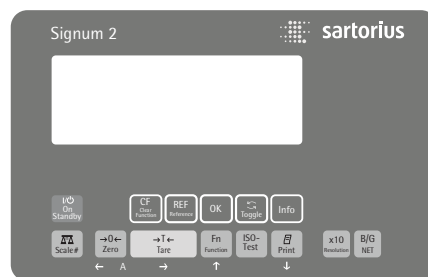
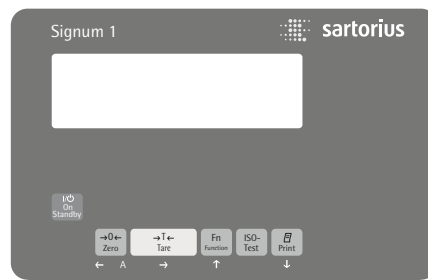

Combining Application Programs – for Signum 3 Only:

The following table shows how the application programs can be combined. Each row represents one combination. The basic weighing function is available at all times; it does not need to be combined with a computational function. Select Application 1, then Application 2, then Application 3. Press the  key to scroll through the available programs.

Application 1 (Basic Function)	Application 2 (Monitoring Function)	Application 3 (Cumulative-value Function)
Counting	–	Totalizing
Counting	Checkweighing	Totalizing
Counting	Checkweighing	–
Counting	Classification	–
Neutral measurement	–	Totalizing
Neutral measurement	Checkweighing	Totalizing
Neutral measurement	Checkweighing	–
Neutral measurement	Classification	–
Animal weighing	–	Totalizing
Animal weighing	Checkweighing	Totalizing
Animal weighing	Checkweighing	–
Animal weighing	Classification	–
Weighing in percent	–	Totalizing
Weighing in percent	Checkweighing	Totalizing
Weighing in percent	Checkweighing	–
Weighing in percent	Classification	–
–	–	Net-total formulation
–	Checkweighing	Totalizing
–	Classification	Totalizing

Application: Counting



With the Counting program you can determine the number of parts that each have approximately equal weight.

Features



Signum 3 only:

- Enter the reference sample weight ("WREF") via the keypad
- Save the reference weight "WREF" from the weighing platform



Signum 3 only:

- Enter the reference sample quantity "NREF" via the keypad
- Enter reference sample weight using a bar code scanner
- Automatic reference sample updating
- Counting with two weighing platforms
- Activate info-mode by pressing 
- Toggle the display between quantity and weight by pressing 
- Define the resolution (level of accuracy) applied when a calculated reference sample weight is stored
- Automatic taring of container weight. Configure these options in the operating menu, under:
APPL 1: A.TARE: 3.7.
(autotare first weight)
- Automatic initialization when the Signum is switched on. The display and control unit is initialized with the most recently used values for reference sample quantity "NREF" and reference sample weight "WREF".
Operating menu setting:
APPL 1: COUNT.: 3.8.
(start APP. with last values)
- Closing application program; deleting parameters:
The value for reference sample weight remains active in the reference memory until you delete it by pressing the  key, overwrite it or until you select a different application. It also remains saved after the scale has been switched off.

Signum 3 only:

You can select the function of the  key for clearing application data. When an application is active, this key can either delete the values saved for all applications, or delete selected values saved for the active application.
Operating menu setting:
APPL 1: SEL.CF: 3.24.
(select CF key  function in applications)

- Tare function:

- 1) If you store a tare (weight value) by pressing the  key, you can later enter a tare value manually. The tare value you enter is added to the stored tare value.
Setting: menu code 3.25.1 (factory default)
- 2) A tare value entered manually overwrites a stored tare value (weight value). If you enter a tare value manually, a tare value (weight value) stored later overwrites the manually entered value.
Setting: menu code 3.25.2
Operating menu setting:
Signum 2
APPL :  : 3.25.
Signum 3
APPL : TARE.F : 3.25.



- Restore factory default settings. Operating menu setting:

Signum 2:
APPL :  : 9.1.

Signum 3:

APPL : DEF.APP : 9.1.

Before the quantity on the platform can be calculated, the reference sample weight (average weight of one piece) must be entered in the application. There are three ways to enter this value in the program:

- Calculation:
 - Place the number of parts defined as the reference sample quantity on the weighing platform and press  to calculate the reference sample weight
 - Alternatively you can place any number of parts on the weighing platform, enter the number of parts using the keypad, and then press the  key to calculate the average piece weight

How the reference weight is calculated depends on the application setting for resolution. The value is either rounded off in accordance with the display resolution, or saved with 10-fold or 100-fold increased resolution, or with the maximum internal resolution of the weighing platform.

Signum 3 only:







- Keypad input: Enter a reference sample weight (i.e., the weight of one piece) using the keypad and press  to save it.
- Bar code input: Enter the reference sample weight using a bar code scanner

After initialization, you can use the connected weighing platform to count parts.

The initial application values are valid until deleted by pressing the  key, or until overwritten by new values. They also remain saved after you switch off the scale.

Application: Counting

Preparation

- Switch on the scale: Press 
- While all segments are lit, press the  key
- Select the Application menu: Press  repeatedly until *APPL* is displayed
- Open the Application menu: Press the  key
- Select the Counting application: Press the  key repeatedly until the desired menu item is displayed and press  to open the submenu

Application Parameters: Counting

— 3.6.	Minimum Load for Initialization	
—	3.6.1*	1 digit
—	3.6.2	2 digits
—	3.6.3	5 digits
—	3.6.4	10 digits
—	3.6.5	20 digits
—	3.6.6	50 digits
—	3.6.7	100 digits
—	3.6.8	200 digits
—	3.6.9	500 digits
—	3.6.10	1000 digits
— 3.9.	Resolution for Calculation of Reference Value	
—	3.9.1*	Display resolution
—	3.9.2	Display resolution + 1 decimal place
—	3.9.3	Display resolution + 2 decimal places
—	3.9.4	Internal resolution
— 3.11	Storage Parameter	
—	3.11.1*	At stability
—	3.11.2	At increased stability
— 3.12.	Reference sample updating	
—	3.12.1	Off
—	3.12.3*	Automatic
— 3.13.	Reference Weighing Instrument	
—	3.13.1*	No reference instrument selected
—	3.13.2	WP1
—	3.13.3	WP2

* = Factory setting

Storage Parameter

The weight on the platform is saved as a reference when the scale has stabilized. “Stability” is defined as the point at which the fluctuation of a measured value lies within a defined tolerance range. The narrower the tolerance range, the more stable the platform is at stability.

In the operating menu, under: *APPL 1: COUNT: 3.11*, you can define whether the value is saved when “standard stability” is reached, or only at “increased stability” (narrower tolerance range. If you select “At increased stability,” the reference sample weight stored will be more accurate and the results more reproducible, but the response time of the weighing instrument might be longer.

Accuracy Level for Calculating Reference Weight

The resolution applied for calculating the reference weight is defined in the operating menu under: *APPL 1: COUNT: 3.9*. The resolution for calculating the reference sample weight is increased if “+1 decimal place”, “+2 decimal places” or “With internal resolution” is selected. With the “+1 decimal place” setting, the net value is determined to one additional decimal place (i.e., display accuracy × 10); the “+2 decimal places” increases display accuracy × 100, and so on up to the maximum resolution available.

Minimum Load

The minimum load required for initialization of the weighing platform is configured in the operating menu under: *APPL 1: COUNT: 3.6*. Once the limit is exceeded by the load, initialization can begin. If the load is too light, the following will occur when you try to save a value:



- The error code *INF 29* is displayed
- The weighing platform is not initialized
- The preset reference sample quantity is saved

The minimum load required for automatic taring of the container weight on the platform (“autotare first weight”) is configured in the operating menu under: *APPL: M.WEIGH: 3.5*.

You can choose from the following 10 levels for this setting:

- 1 digit
- 2 digits
- 5 digits
- 10 digits
- 20 digits
- 50 digits
- 100 digits
- 200 digits
- 500 digits
- 1000 digits

The “digits” here refer to the scale intervals in the connected weighing platform. If the interval of the connected weighing platform is 1 g, for example, and 1000 digits are required, you must place at least 1000 g (= 1000 intervals = 1000 digits) on the weighing platform for initialization.

- Press  to save your settings and  (repeatedly) to exit the operating menu.

Reference Sample Updating

In the operating menu, under:

APPL 1: COUNT: 3. 12.

you can define whether or not the reference sample weight is automatically updated during weighing. Reference sample updating is performed automatically only when the following 6 criteria are met:

1. The APW Update item in the operating menu is set to *3. 12.3* ("Automatic").
2. The current piece count exceeds the original piece count by at least two
3. The current piece count is less than twice the original piece count (does not apply for the first updating operation if the piece count is entered using the keypad or a bar code scanner)
4. The new piece count is less than 1000

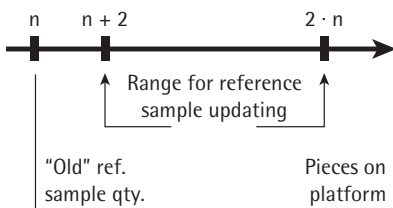

5. The internally calculated piece count (e.g., 17.24 pcs) differs by less than ± 0.3 pcs from the nearest whole number (in this example: 17).
6. The scale is stable in accordance with the defined stability parameter.

If automatic reference sample updating is selected in the operating menu and the piece count (pcs) is displayed, the *AUTO* symbol is displayed below the bar graph. If the reference sample weight has been updated since you began weighing, the text line shows the "optimized" code: (*OPT.*). During an updating operation, *OPT* and the updated piece count are displayed briefly in the measured value line.

The new reference sample weight and reference sample quantity are saved.

Counting with Two Weighing Platforms

You can use two weighing instruments simultaneously with the Counting application. When using two platforms, you can choose from the following operating modes:

- Counting with two equivalent weighing platforms
- Counting with one reference weighing instrument and one counting platform

Counting with two equivalent weighing platforms:

Use this mode when samples of widely varying weight are counted at one workstation. For example, count the lighter-weight pieces on one platform and the heavier pieces on another. You can define which of the two platforms is active when the Signum is switched on. This is configured in the operating menu, under:

SETUP:

UTILIT:

B. 11. : (main scale)

The main scale is the first platform active when you switch on the Signum, regardless of the setting for automatic initialization of the Counting application.

Counting with one reference weighing instrument and one counting platform:

In this mode, a high-resolution weighing instrument with a relatively low maximum capacity is used as a reference weighing instrument. The counting platform has a high capacity, but a relatively low resolution.

This allows you to both determine the reference sample weight with high resolution; i.e., very precisely, and to count large amounts of parts, without requiring an expensive high-resolution, high-capacity weighing platform.

The system can be configured to switch automatically to the reference instrument for initialization (the measured value line shows *REF*). Following initialization, you can switch to the counting platform.

The definition of one weighing instrument as the reference instrument is configured in the operating menu, under:

APPL 1: COUNT: 3. 13.

If automatic reference sample updating is enabled, the update is performed on the active platform; in other words, the system does not automatically switch to the reference instrument.

Application: Counting

Example:

Determining the number of uncounted parts.

Settings (changes in the factory settings required for this example):

Application parameters: Application: Counting

Setup: Printout: *PRTPROT*: 7.6.; then select menu line item of your choice (see "Configuration" for options)

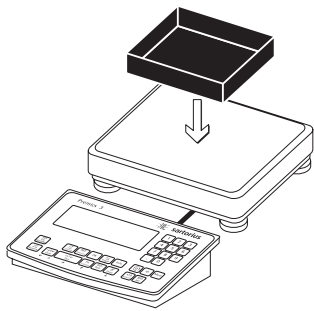

- 1 Place empty container on the platform

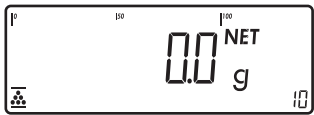

- 2 Tare the scale
Note: If the automatic tare function is enabled, you do not need to press the  key to tare the scale; the tare weight is saved automatically when you place the container on the platform.

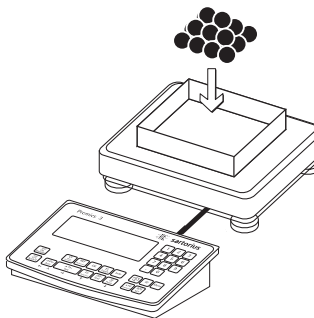

- 3 Place a number of parts in the container for the reference quantity (in this example, 20 pcs)

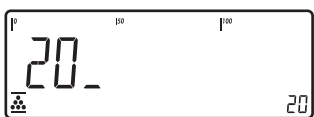

- 4 Enter the number of parts using the keypad



- 5 Activate calculation of reference sample weight

If the weight is too light, *INF 29* is shown in the main display.

Reduce the minimum load setting or increase the reference sample quantity and the number of parts in the container.

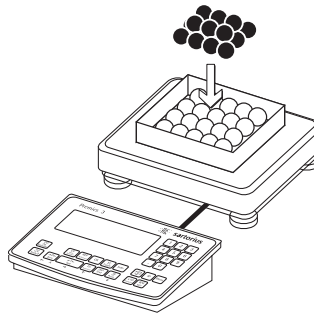

- 6 Add more parts to the container

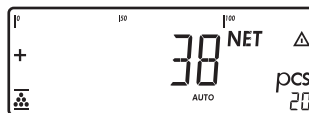

Read the result

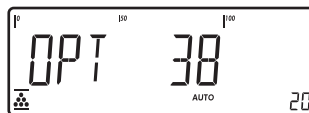

OPT is displayed if automatic reference sample updating is enabled



- 7 Print the results

nRef + 38 pcs
wRef + 0.003280 kg
Configured printout: see page 81

G# + 0.373 kg
T + 0.248 kg
N + 0.125 kg

Qnt 38 pcs

Application: Neutral Measurement NIM

With this application you can use your weighing platform to measure the length, surface and volume of parts that have roughly the same specific weight. The \square symbol is displayed as the weight unit.

Features

Signum 3 only:

- Enter the reference weight “wRef” via the keypad
 - Save the reference weight “wRef” from the weighing platform
- Signum 3 only:
- Enter the factor for calculation “nRef” via the keypad
 - Enter reference sample weight using a bar code scanner
 - Measure with two weighing platforms
 - Activate info-mode by pressing **[Info]**
 - Toggle the display between measurement and weight by pressing **[S]**
 - Define the level of accuracy (display resolution) applied when a calculated reference value is saved
 - Automatic taring of container weight.
Operating menu setting:
APPL : A.TARE : 3.7.
(autotare first weight)
 - Automatic initialization when the Signum is switched on. The display and control unit is initialized with the most recently used calculation factor “nRef” and reference weight “wRef”. Operating menu setting:
APPL : A.START : 3.8.
(start app. with last values)
 - Closing application program; deleting parameters:
The value for reference sample weight remains active in the reference memory until you delete it by pressing the **[CF]** key, overwrite it or until you select a different application. It also remains saved after the scale has been switched off.

Signum 3 only:

You can select the function of the **[CF]** key for clearing application data. When an application is active, this key can either delete the values saved for all applications, or delete selected values saved for the active application. Operating menu setting:
APPL : SEL.CF : 3.24.
(select CF key function in applications)

- Tare function:
 - 1) If you store a tare (weight value) by pressing the **[T+]** key, you can later enter a tare value manually. The tare value you enter is added to the stored tare value.
Setting: menu code 3.25.1 (factory default)
 - 2) A tare value entered manually overwrites a stored tare value (weight value). If you enter a tare value manually, a tare value (weight value) stored later overwrites the manually entered value.
Setting: menu code 3.25.2
Operating menu setting:
Signum 2
APPL : M : 3.25.
Signum 3
APPL : TARE.F : 3.25.
 - Restore factory default settings. Operating menu setting:
Signum 2:
APPL : NM : 9.1.
Signum 3:
APPL : DEF.APP : 9.1.
- In order to calculate the length, surface or volume of a given sample, the average weight of a reference quantity of the sample must be known (in the example below, the reference is 1 meter of electrical cable). There are three ways to enter the reference weight in the program:
- Calculation:
 - Place the reference quantity (defined by the calculation factor) on the connected weighing platform and calculate the reference sample weight by pressing the **[OK]** key.
 - Place any amount of the sample material on the connected weighing platform, enter the calculation factor through the keypad, and press the **[OK]** key to calculate the reference sample weight.

How the reference weight is calculated depends on the application setting for resolution. The value is either rounded off in accordance with the display resolution, or saved with 10-fold or 100-fold increased resolution, or with the maximum internal resolution of the weighing platform.

- Keypad input: Enter the reference weight (i.e., the weight of one meter of electrical cable) using the keypad and press **[OK]** to save it.
- Bar code: If the value is available in bar code, you can use a bar code scanner to enter the reference weight

The initial application values are valid until deleted by pressing the **[CF]** key, or until overwritten by new values. They also remain saved after you switch off the scale.

Preparation

- Switch on the scale: Press **[ON]**.
- While all segments are lit, press the **[T+]** key
- Select the Application menu: Press **[Fn]** repeatedly until *APPL* is displayed
- Open the Application menu: Press the **[T+]** key

- Select the Neutral Measurement application:
Press the **[Fn]** key repeatedly until the desired menu item is displayed and press **[T+]** to open the submenu

Application Parameters:
Neutral Measurement

3.6.	Minimum Load for Initialization	
— 3.6.1*	1 digit	
— 3.6.2	2 digits	
— 3.6.3	5 digits	
— 3.6.4	10 digits	
— 3.6.5	20 digits	
— 3.6.6	50 digits	
— 3.6.7	100 digits	
— 3.6.8	200 digits	
— 3.6.9	500 digits	
— 3.6.10	1000 digits	
3.9.	Resolution for Calculation of Reference Value	
— 3.9.1*	Display resolution	
— 3.9.2	Display resolution + 1 decimal place	
— 3.9.3	Display resolution + 2 decimal places	
— 3.9.4	Internal resolution	
3.10.	Decimal Places in Displayed Result	
— 3.10.1*	None	
— 3.10.2	1 decimal place	
— 3.10.3	2 decimal places	
— 3.10.4	3 decimal places	
3.11.	Storage Parameter	
— 3.11.1*	At stability	
— 3.11.2	At increased stability	
3.13.	Reference Weighing Instrument	
— 3.13.1*	Off	
— 3.13.2	WP1	
— 3.13.3	WP2	

* = Factory setting

- Press and hold **[T+]** to save your settings. Press **[ON]** (repeatedly) to exit the operating menu.

Storage Parameter

The reference weight is saved when the scale has stabilized. "Stability" is defined as the point at which fluctuation of a measured value lies within a defined tolerance range. The narrower the tolerance range, the more stable the platform is at stability.

In the operating menu, under:

APPL 1:

NEUTR.M: 3. 11.

you can define whether the value is saved when "standard stability" is reached, or only at "increased stability" (narrower tolerance range). If you select "At increased stability," the reference weight saved will be more accurate and the results more reproducible, but the response time of the weighing instrument might be longer.

Accuracy Level for Calculation of Reference Value

The resolution applied for calculating the reference weight is defined in the operating menu under:

APPL 1:

NEUTR.M: 3.9.

The resolution for calculating the reference sample weight is increased if "+1 decimal place", "+2 decimal places" or "With internal resolution" is selected. With the "+1 decimal place" setting, the net value is determined to one additional decimal place (i.e., display accuracy $\times 10$); "+2 decimal places" increases display accuracy $\times 100$, and so on up to the maximum resolution available.

Decimal Places for Display of Results

In neutral measurement, not only whole numbers but also decimal numbers (for example, 1.25 \square electrical cabling) can be displayed. The number of decimal places displayed in neutral measurement is configured in the operating menu under:

APPL 1:

NEUTR.M: 3. 10.

Minimum Load

The minimum load required for initialization of the weighing platform is configured in the operating menu, under:

APPL 1:

NEUTR.M: 3.6.

Once the limit is exceeded by the load, initialization can begin. If the load is too light, the following will occur when you try to save a value:

- The error code *INF 29* is displayed
- The scale is not initialized
- The preset calculation factor is saved

The minimum load required for automatic taring of the container weight on the platform ("autotare first weight") is configured in the operating menu under:

APPL 1: M.WEIGH: 3.5.

You can choose from the following 10 levels for this setting:

- 1 digit
- 2 digits
- 5 digits
- 10 digits
- 20 digits
- 50 digits
- 100 digits
- 200 digits
- 500 digits
- 1000 digits

The "digits" here refer to the scale intervals in the connected weighing platform. If the interval of the connected weighing platform is 1 g, for example, and 1000 digits are required, you must place at least 1000 g (=1000 intervals =1000 digits) on the weighing platform for initialization.

Neutral Measurement with Two Weighing Platforms

You can use two weighing platforms simultaneously with the Neutral Measurement application. When using two platforms, you can choose from the following operating modes:

- Neutral measurement with two equivalent weighing platforms
- Neutral measurement with one reference weighing instrument and one measurement platform

Neutral Measurement with two equivalent weighing platforms:

Use this mode when samples of widely varying weight are measured at one workstation. For example, measure the lighter-weight samples on one platform and the heavier samples on another.

You can define which of the two platforms is active when the Signum is switched on. This is configured in the operating menu, under:

SETUP:

UTILIT:

B. 11. : (main scale)

The main scale is the first platform active when you switch on the Signum, regardless of the setting for automatic initialization of the Neutral Measurement application.

Neutral measurement with one reference weighing instrument and one measurement platform:

In this mode, a high-resolution weighing instrument with a relatively low maximum capacity is used as a reference weighing instrument. The measuring platform has a high capacity, but a relatively low resolution.

This allows you to both determine the reference value with high resolution; i.e., very precisely, and to measure large samples, without requiring an expensive high-resolution, high-capacity weighing platform.

The system can be configured to switch automatically to the reference instrument for initialization. Following initialization, the platform for larger amounts is automatically activated.

The definition of one weighing instrument as a reference instrument is configured in the operating menu, under:

APPL 1:

NEUTR.M: 3. 13.

Example:

Measuring 25 m electrical cable.

Settings (changes in the factory settings required for this example):

Application parameters: Application: Neutral Measurement

Setup: Printout: *PRTPROT: 7.5.*; then select menu line item of your choice (see "Configuration" for options)

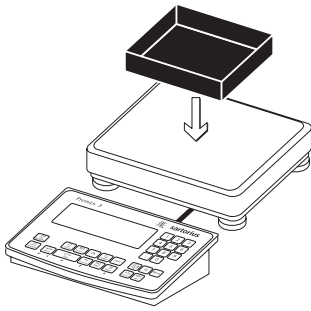

1 Place empty container on the platform

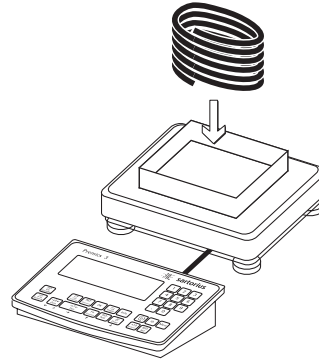

5 Place the desired amount of cable in the container



2 Tare the scale
Note: If the automatic tare function is enabled, you do not need to press the  key to tare the scale; the tare weight is saved automatically when you place the container on the platform



Read the result

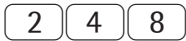

3 Enter the weight of 1 meter of cable using the keypad (in this example, 248 g)

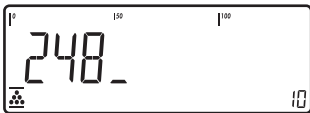

6 Print the result

nRef	+	1	o	Configured printout: see page 81
wRef	+	0.248	kg	
G#	+	6.794	kg	
T	+	0.541	kg	
N	+	6.253	kg	



4 Save value entered as reference weight.

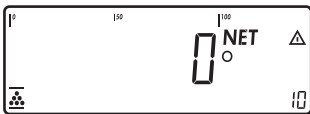

Qnt		25	o

Application: Averaging (Animal Weighing)

With the Averaging application, you can use your scale for calculating weights as the average of a number of individual weighing operations.

This function is used to determine weights under unstable ambient conditions or for weighing unstable samples (such as live animals).

Features

- Averaging starts manually or automatically. Configure in the operating menu, under:

APPL 1: ANIM.WG: 3.18.

With manual start selected, the averaging routine begins when you press a key (provided the start conditions are met). With automatic start selected, averaging begins when you place the first load on the platform (provided the start conditions are met).

Signum 3 only:

- Enter the number of subweighing operations using the keypad
- Press the **[REF]** key to select the desired number of subweighing operations.
- Info mode
- Toggle the display between last result and current weight by pressing **[S]**
- Automatic printout of results. Configure in the operating menu, under:
APPL 1:
ANIM.WG: 3.20.
- Automatic taring of container weight. Operating menu setting:
APPL 1:
ANIM.WG: 3.7.
- Automatic start of averaging when the Signum is turned on and a sample placed on the platform (provided start conditions are met). Configure in Setup under:
APPL: A.START: 3.8.

- Closing application program; deleting parameters:
The number of measurements remains active in the reference memory until you delete it by pressing the **[CF]** key, overwrite it or until you select a different application. It also remains saved after the scale has been switched off.

Signum 3 only:

You can select the function of the **[CF]** key for clearing application data. When an application is active, this key can either delete the values saved for all applications, or delete selected values saved for the active application. Operating menu setting:
APPL: SEL.CF: 3.24.
(select CF key function in applications)

- Tare function:
 - 1) If you store a tare (weight value) by pressing the **[T]** key, you can later enter a tare value manually. The tare value you enter is added to the stored tare value.
Setting: menu code 3.25.1 (factory default)
 - 2) A tare value entered manually overwrites a stored tare value (weight value). If you enter a tare value manually, a tare value (weight value) stored later overwrites the manually entered value.
Setting: menu code 3.25.2
Operating menu setting:
Signum 2
APPL: : 3.25.
Signum 3
APPL: TARE.F: 3.25.

- Restore factory default settings. Operating menu setting:
Signum 2:
APPL: : 9.1.

Signum 3:

APPL: DEF.APP: 9.1.

A number of subweighing operations are required to form the basis for calculation of an average weight. You can enter the desired number of subweighing operations using the keypad.

The number you enter is saved until it is overwritten by another number. It also remains in memory when you switch to a different application program, or switch off the scale.

There are three ways to start the averaging routine:

- Manual start with preset number of subweighing operations:
Place the sample on the platform and press the **[OK]** key
- Manual start with user-defined number of measurements:
Place the sample on the platform and enter the number of weighing operations using the keypad. Press the **[REF]** key to save the number entered and begin weighing
- Automatic start with preset number of subweighing operations:
Measurement begins when you place the first sample on the platform, provided the start conditions are met.

Preparation

- Switch on the scale: Press **(I/O)**.
- While all segments are lit, press the **(→T←)** key
- Select the Application menu: Press **(Fn)** repeatedly until *APPL* is displayed
- Open the Application menu: Press the **(→T←)** key
- Select the Animal Weighing application: Press the **(Fn)** key repeatedly until the desired menu item is displayed and press **(→T←)** to open the submenu

Application Parameters: Averaging (Animal Weighing)

3.6.	Minimum Load	
3.6.1*	1 digit	
3.6.2	2 digits	
3.6.3	5 digits	
3.6.4	10 digits	
3.6.5	20 digits	
3.6.6	50 digits	
3.6.7	100 digits	
3.6.8	200 digits	
3.6.9	500 digits	
3.6.10	1000 digits	
3.18.	Start of Averaging Routine	
3.18.1*	Manual	
3.18.2	Automatic	
3.19.	Averaging	
3.19.1	0.1% of the animal/object	
3.19.2*	0.2% of the animal/object	
3.19.3	0.5% of the animal/object	
3.19.4	1% of the animal/object	
3.19.5	2% of the animal/object	
3.19.6	5% of the animal/object	
3.19.7	10% of the animal/object	
3.19.8	20% of the animal/object	
3.19.9	50% of the animal/object	
3.19.10	100% of the animal/object	
3.20.	Automatic Printout of Results	
3.20.1*	Off	
3.20.2	On	
3.21.	Static Display After Load Removed	
3.21.1*	Display is static until unload threshold reached	
3.21.2	Display is static until (CF) is pressed	

* = Factory setting

- Press **(→T←)** to save your settings and press **(→O←)** (repeatedly) to exit the operating menu.

Minimum Load

The minimum load required for initialization of the averaging routine is configured in the operating menu, under:

APPL 1:
ANIM.WG: 3.6.

Setting a minimum load for averaging can be especially useful if you configure automatic start of measurement.

The minimum load required for automatic taring of the container weight on the platform (“autotare first weight”), or for automatic printout of results, is configured in the operating menu, under:

APPL: A.TARE: 3.5.

You can choose from the following 10 levels for this setting:

- 1 digit
- 2 digits
- 5 digits
- 10 digits
- 20 digits
- 50 digits
- 100 digits
- 200 digits
- 500 digits
- 1000 digits

The “digits” here refer to the scale intervals in the connected weighing platform. If the interval of the connected platform is 1 g, for example, and 1000 digits are required, you must place at least 1000 g (=1000 intervals =1000 digits) on the weighing platform to start the averaging routine.

Starting the Measurements

The averaging routine does not begin until the fluctuation in weight value remains below a defined threshold over three consecutive measurements. The tolerance limit is defined as a percentage of the animal or object weight (for example, 0.1%; 0.2%; ...; 50%; 100%), configured in the operating menu, under:

APPL 1:
ANIM.WG: 3.19.

If the “Animal activity” parameter is set to 2%, for example, and the animal or object weighs 10 kg, measurement does not begin until the fluctuation in weight value remains below 200 g during three consecutive measurements.

Display

A calculated average value is shown continuously on the main display. The **(△)** symbol (indicating a calculated value) is also displayed.

You can toggle between this display and a readout of the current weight on the scale by pressing the **(S)** key.

In the operating menu, under:

APPL 1:
ANIM.WG: 3.21.

you can select “Display is static until unload threshold reached” to have the display switch automatically to the weight readout when you unload the weighing platform (i.e., when the load is less than half the minimum load). The result of the most recent averaging operation is not saved.

If you select “Display is static until **(CF)** is pressed,” the calculated average remains displayed even after the weighing platform is unloaded, until you press the **(CF)** key or begin a new measurement.

Application: Averaging (Animal Weighing)

Example:

Measuring the weight of one mouse.

Settings (changes in the factory settings required for this example):

Application parameters: Application: Animal weighing

Setup: Printout: *PRTPROT*: 7.6.; then select menu line item of your choice (see "Configuration" for options)

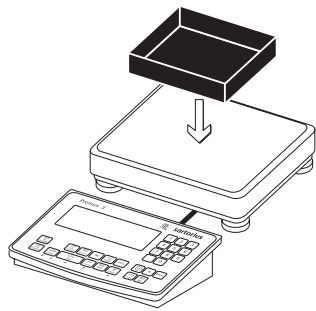

Place empty container on the platform

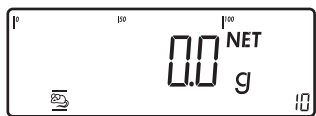

- 1 Tare the scale.
Note: If the automatic tare function is enabled, you do not need to press the  key to tare the scale; the tare weight is saved automatically when you place the container on the platform.

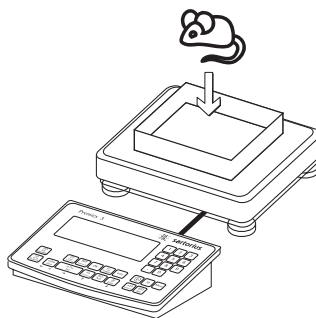

- 2 Place 1st animal in container

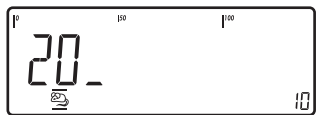

- 3 Enter the number of subweighing operations using the keypad (in this example, 20 measurements)



- 4 Save the value entered and begin averaging



The averaging routine does not begin until the fluctuation in weight value remains below a defined threshold over three consecutive measurements. The number of subweighing operations remaining is shown in the numeric display.



Read off the result of averaging.



- 5 Print the results.
Note: If automatic printout of results is enabled, you do not need to press the  key; the results are printed automatically.

```
mDef +      20
T      +      0.292 kg
x-Net +      0.183 kg
```

Configured printout: see page 81

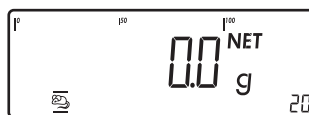

When you unload the weighing platform, the display switches to the weight readout automatically, unless configured otherwise in Setup. The weighing instrument is ready for the next measurement.

Application: Weighing in Percent %

With the Weighing in Percent application, you can have the value of the weight on the platform displayed as a percentage calculated in relation to a defined reference weight. The % symbol is displayed in place of the weight unit.

Features

Signum 3 only:

- Enter the reference weight “Wxx%” for 100% via the keypad

- Save the current weight value as reference percentage (“pRef”)

Signum 3 only:

- Enter the reference percentage “pRef” via the keypad
- Enter reference sample weight using a bar code scanner
- Display result as loss (difference) or residue
- Display up to 3 decimal places. Configure in the operating menu, under:
APPL 1:
PERC.WG: 3.10.
- Weigh in percent with two weighing platforms
- Activate info-mode by pressing [Info]
- Toggle the display between percentage and weight by pressing the [↔] key.
- Automatic taring of container weight. Operating menu setting:
APPL : A.TARE : 3.7.
- Automatic initialization when the Signum is switched on. The application is initialized with the most recently saved data. Operating menu setting:
APPL : A.START : 3.8.
- Closing application program; deleting parameters:
The value for reference sample weight remains active in the reference memory until you delete it by pressing the [CF] key, overwrite it or until you select a different application. It also remains saved after the scale has been switched off.

Signum 3 only:

You can select the function of the [CF] key for clearing application data. When an application is active, this key can either delete the values saved for all applications, or delete selected values saved for the active application. Operating menu setting:
APPL : SEL.CF : 3.24.
(select CF key function in applications)

- Tare function:
 - 1) If you store a tare (weight value) by pressing the [⇨T⇩] key, you can later enter a tare value manually. The tare value you enter is added to the stored tare value.
Setting: menu code 3.25.1 (factory default)
 - 2) A tare value entered manually overwrites a stored tare value (weight value). If you enter a tare value manually, a tare value (weight value) stored later overwrites the manually entered value.
Setting: menu code 3.25.2
Operating menu setting:
Signum 2
APPL : % : 3.25.
Signum 3
APPL : TARE.F : 3.25.
- Restore factory default settings. Operating menu setting:
Signum 2:
APPL : % : 9.1.

Signum 3:
APPL : DEF.APP : 9.1.

To determine the weight of a sample relative to a reference weight, you need to define the reference weight value. There are three ways to enter this value in the application program:
- Calculation:
 - Place the reference quantity (defined by the reference percentage) on the connected weighing platform and press [OK].
 - Place any amount of the sample material on the connected weighing platform, enter the reference percentage through the keypad, and press the [REF] key to initialize the application.
How the reference weight is calculated depends on the application setting that defines “Accuracy for saving weights.” The value is either rounded off in accordance with the display resolution, or saved with 10-fold or 100-fold increased resolution, or with the maximum internal resolution of the weighing platform.
- Enter the reference weight for 100% via the keypad and press the [OK] key to initialize the application.

- Bar code: If the value is available in bar code, you can use a bar code scanner to enter the reference weight

The initial application values are valid until deleted by pressing the [CF] key or until overwritten by new values. They also remain saved after you switch off the Signum.

Preparation

- Switch on the scale: Press [I/O].
- While all segments are lit, press the [⇨T⇩] key
- Select the Application menu: Press [Fn] repeatedly until APPL is displayed
- Open the Application menu: Press the [⇨T⇩] key
- Select the Weighing in Percent application: Press the [Fn] key repeatedly until the desired menu item is displayed and press [⇨T⇩] to open the submenu

Application Parameters:
Weighing in Percent

3.6.	Minimum Load for Initialization
— 3.6.1*	1 digit
— 3.6.2	2 digits
— 3.6.3	5 digits
— 3.6.4	10 digits
— 3.6.5	20 digits
— 3.6.6	50 digits
— 3.6.7	100 digits
— 3.6.8	200 digits
— 3.6.9	500 digits
— 3.6.10	1000 digits
3.9.	Resolution for Calculation of Reference Value
— 3.9.1*	Display resolution
— 3.9.2	Display resolution + 1 decimal place
— 3.9.3	Display resolution + 2 decimal places
— 3.9.4	Internal resolution
3.10.	Decimal Places in Displayed Result
— 3.10.1*	None
— 3.10.2	1 decimal place
— 3.10.3	2 decimal places
— 3.10.4	3 decimal places
3.11	Storage Parameter
— 3.11.1*	At stability
— 3.11.2	At increased stability
3.13.	Reference Weighing Instrument
— 3.13.1*	No reference instrument selected
— 3.13.2	WP1
— 3.13.3	WP2
3.15.	Display of Calculated Value
— 3.15.1*	Residue
— 3.15.2	Loss

* = Factory setting

- Press [⇨T⇩] to save your settings and press [⇨O⇩] (repeatedly) to exit the operating menu.

Application: Weighing in Percent %

Parameter for saving weight

The reference weight is saved when the platform has stabilized. "Stability" is defined as the point at which fluctuation of a measured value lies within a defined tolerance range. The narrower the tolerance range, the more stable the platform is at stability.

In the operating menu, under:

APPL 1:

PERC.WG: 3.11.

you can define whether the value is saved when "standard stability" is reached, or only at "increased stability" (narrower tolerance range. If you select "At increased stability," the reference weight saved will be more accurate and the results more reproducible, but the response time of the weighing instrument might be longer.

Accuracy Level for Calculating Reference Weight

The resolution applied for calculating the reference weight is defined in the operating menu under:

APPL 1:

PERC.WG: 3.9.

The resolution for calculating the average piece weight is increased if "+1 decimal place", "+2 decimal places" or "With internal resolution" is selected. With the "+1 decimal place" setting, the net value is determined to one additional decimal place (i.e., display accuracy $\times 10$); "+2 decimal places" increases display accuracy $\times 100$, and so on up to the maximum resolution available

Display of Results

With the Weighing in Percent application, the result can be displayed as a remainder or loss.

Operating menu setting:

APPL 1:

PERC.WG: 3.15.

Equations:

$$\text{Residue} = (\text{current weight} - 100\% \text{ weight}) / * 100$$

$$\text{Loss} = (\text{current weight} - 100\% \text{ weight}) / 100\% \text{ weight} * 100$$

Minimum Load

The minimum load required for initialization of the weighing platform is configured in the operating menu, under:

APPL 1:

PERC.WG: 3.6.

Once the limit is exceeded by the load, initialization can begin. If the load is too light, the following will occur when you try to save a value:

- The error code *INF 29* is displayed
- The weighing platform is not initialized
- The preset reference percentage is saved

The minimum load required for automatic taring of the container weight on the platform ("autotare first weight") is configured in the operating menu under:

APPL 1: M.WEIGH: 3.5.

You can choose from the following 10 levels for this setting:

- 1 digit
- 2 digits
- 5 digits
- 10 digits
- 20 digits
- 50 digits
- 100 digits
- 200 digits
- 500 digits
- 1000 digits

The "digits" here refer to the scale intervals in the connected weighing platform. If the interval of the connected weighing platform is 1 g, for example, and 1000 digits are required, you must place at least 1000 g (=1000 intervals =1000 digits) on the weighing platform for initialization.

Weighing in Percent with Two Weighing Platforms

You can use two weighing platforms simultaneously with the Weighing in Percent application. When using two platforms, you can choose from the following operating modes:

- Weighing in Percent with two equivalent weighing platforms
- Weighing in Percent with one reference weighing instrument and one weighing platform

Weighing in Percent with two equivalent weighing platforms:

Use this mode when samples of widely varying weight are measured at one workstation. For example, measure the lighter-weight samples on one platform and the heavier samples on another.

You can define which of the two platforms is active when the Signum is switched on. This is configured in the operating menu, under:

SETUP: UTILIT: 8.11.

(main scale)

The main scale is the first platform active when you switch on the Signum, regardless of the setting for automatic initialization of the Weighing in Percent application.

Weighing in Percent with one reference weighing instrument and one measuring platform:

In this mode, a high-resolution weighing instrument with a relatively low maximum capacity is used as a reference weighing instrument. The measuring platform has a high capacity, but a relatively low resolution.

This allows you to both determine the reference weight with high resolution; i.e., very precisely, and to measure large samples, without requiring an expensive high-resolution, high-capacity weighing platform.

The system can be configured to switch automatically to the reference instrument for initialization (the measured value line shows Ref). Following initialization, the platform for larger amounts is automatically activated.

The definition of one weighing instrument as a reference instrument is configured in Setup, under:

APPL 1:

PERC.WG: 3.13.

Example:

Weighing in 100% of a sample material.

Settings (changes in the factory settings required for this example):

Application parameters: Application: Weighing in percent

Setup: Printout: *PRTPROT: 7.5.*; then select menu line item of your choice (see "Configuration" for options)

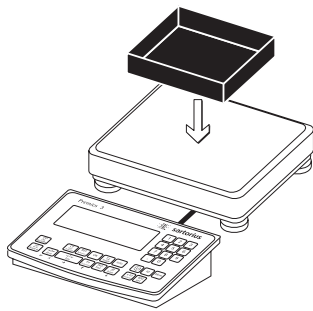

1 Place empty container on the platform



If the weight is too light, the error code *INF 29* is shown in the main display.

Reduce the minimum load setting.

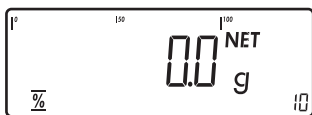

2 Tare the scale
Note: If the automatic tare function is enabled, you do not need to press the $\rightarrow T \leftarrow$ key to tare the scale; the tare weight is saved automatically when you place the container on the platform

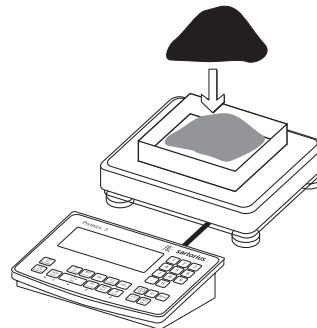

5 Continuing filling the container until the target amount is reached (in this example, 100%)

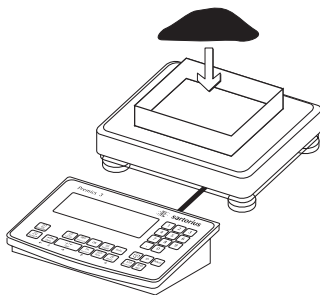

3 Add reference material in accordance with reference percentage (in this example, 85 g)

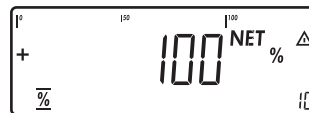

6 Print the result



4 Activate calculation of the reference weight. The calculation is based on the active net weight value and the reference percentage entered.

pRef	+	20 %	Configured printout: see page 81
wRef	+	0.085 kg	
G#	+	1.080 kg	
T	+	0.675 kg	
N	+	0.423 kg	
Prc	+	100 %	

Application: Checkweighing $\frac{\%}{\%}$

With the Checkweighing application, you can check whether the sample on the weighing platform matches a target value, or lies within a given tolerance range. Checkweighing also makes it easy to fill sample materials to specified target weight.

Features

Signum 3 only:

- Enter the nominal or target weight (setpoint) and the tolerance range delimiters either using the keypad or by saving the weight value from a load on the platform.

Signum 3 only:

- Enter the tolerance limits as absolute values (Min and Max) or as percentages of the target. Configure in the operating menu under:
APPL 2:
CHECK.WG: 4.5.
- The target value can be taken over as a weighed value from a weighing platform, and the upper and lower tolerance limits are defined as a percentage deviation from the target value. The following percentages can be selected as the deviation: 0.1%, 0.2%, 0.5%, 1%, 1.5%, 2%, 3%, 5% or 10%.
- The target value, lower tolerance limit (minimum) and upper tolerance limit (maximum) can be taken over as weighed values from the weighing platform.
- Target and tolerance limits checked during input; values must conform to: Upper limit \geq Target \geq Lower limit \geq 1 digit.
- Checkweighing range: either 30% to 170% of the target, or from 10% to infinity.
- Results are shown on the main display and the bar graph and sent to control output ports for further processing.
- Toggle the main display between weight and tolerances limits by pressing $\left[\frac{\%}{\%} \right]$. If the weight on the readout is outside the tolerance range, “LL” (too low) or “HH” (too high) is displayed.

- Activate info-mode by pressing $\left[\text{Info} \right]$
- Automatic printout of results. Configure in the operating menu, under:
APPL 2:
CHECK.WG: 4.6.
- Automatic taring of container weight. Configure in the operating menu, under:
APPL : A.TARE: 3.7.
- Automatic initialization when you switch on the Signum with most recently saved application data. Configure in the operating menu, under:
APPL : A.START: 3.8.
- Closing application program; deleting parameters:
You can select the function of the $\left[\text{CF} \right]$ key for clearing application data. When an application is active, this key can either delete the values saved for all applications, or delete selected values saved for the active application. Operating menu setting:
APPL : SEL.CF: 3.24. (select CF key function in applications)
- Tare function:
1) If you store a tare (weight value) by pressing the $\left[\rightarrow T \leftarrow \right]$ key, you can later enter a tare value manually. The tare value you enter is added to the stored tare value.
Setting: menu code 3.25.1 (factory default)
- 2) A tare value entered manually overwrites a stored tare value (weight value). If you enter a tare value manually, a tare value (weight value) stored later overwrites the manually entered value.
Setting: menu code 3.25.2
Operating menu setting:
Signum 2
APPL : $\frac{\%}{\%}$: 3.25.
Signum 3
APPL : TARE.F : 3.25.
- Restore factory default settings. Operating menu setting:
Signum 2:
APPL : $\frac{\%}{\%}$: 9.1.
Signum 3:
APPL : DEF.APP : 9.1.

Checkweighing entails comparing the current weight value to a defined target. You can enter the value for this target using the keypad, or by saving the weight value indicated. You can also define upper and lower tolerance limits based on this target. You can do this by:

- Entering absolute values using the keypad or placing the desired amount of weight on the platform and saving the value, or
- by entering each value as a percentage of the target weight

The initial application values are valid until deleted by pressing the $\left[\text{CF} \right]$ key or until overwritten by new values. They also remain saved after you switch off the scale.

Preparation

- Switch on the scale: Press $\left[\text{I/O} \right]$.
- While all segments are lit, press the $\left[\rightarrow T \leftarrow \right]$ key
- Select the Application menu: Press $\left[\text{Fn} \right]$ repeatedly until *APPL* is displayed
- Open the Application menu: Press the $\left[\rightarrow T \leftarrow \right]$ key
- Select the Checkweighing application: Press the $\left[\text{Fn} \right]$ key repeatedly until the desired menu item is displayed and press $\left[\rightarrow T \leftarrow \right]$ to open the submenu

Application Parameters: Checkweighing

4.2.	Checkweighing range	
4.2.1*	30% to 170%	
4.2.2	10% to infinity	
4.3.	Activate Control Line for “Set” as:	
4.3.1*	“Set” output	
4.3.2	Ready to operate	
4.4.	Activation of Outputs	
4.4.1	Off	
4.4.2	Always active	
4.4.3	Active at stability	
4.4.4*	Active within check range	
4.4.5	Active at stability within the check range	
4.5.	Parameter input	
4.5.1*	Min, max, target	
4.5.2	Only target with percent limits	
4.6.	Automatic Printing	
4.6.1*	Off	
4.6.2	On	
4.6.3	Only values within tolerance	
4.6.4	Only values outside tolerance	
4.7.	Checkweighing toward Zero	
4.7.1*	Off	
4.7.2	On	

* = Factory setting

- Press $\left[\rightarrow T \leftarrow \right]$ to save your settings and press $\left[\rightarrow 0 \leftarrow \right]$ (repeatedly) to exit the operating menu.

Minimum Load

The minimum load required for automatic taring of the container weight on the platform (“autotare first weight”), or for automatic printout of results, is configured in the operating menu, under:

APPL: M.WEIGH: 3.5.

You can choose from the following 10 levels for this setting:

- 1 digit (no minimum load)
- 2 digits
- 5 digits
- 10 digits
- 20 digits
- 50 digits
- 100 digits
- 200 digits
- 500 digits
- 1000 digits

The “digits” here refer to the scale intervals in the connected weighing platform. If the interval of the connected platform is 1 g, for example, and 1000 digits are required, you must place at least 1000 g (=1000 intervals =1000 digits) on the weighing platform to activate autotaring or autoprint.

Display

The result of a measurement is shown either as a weight value or in relation to the target.

- Weight display mode:
The measured value line always shows the weight value, even if it lies outside the tolerance range.

The bar graph is displayed with symbols indicating lower limit, target and upper limit. The bar shows a logarithmic display of the current load if the weight is anywhere from 0 to the minimum load, and a linear display for weights beyond that range.

- Result = Threshold status

As “Weight display mode” above, with the following exceptions:

- *LL* is shown on the main display if the weight value is lower than the target, and
- *HH* is shown on the main display if the weight value is higher than the target

Digital Input/Output Interface

The Checkweighing application supports the digital input/output interface. There are 4 control lines, or outputs, which are activated as follows (see also the diagram on the right):

- Lighter
- Equal
- Heavier
- Set

In the operating menu, under:

APPL 2:

CHECK.WG: 4.4.

you can define whether these control ports are

- off,
- always on,
- activated at stability,
- on within the checking range, or
- active at stability within the checking range

The “SET” output normally changes its voltage level when the load is near the target weight. Alternatively, you can assign the “Operative” function (indicating “Ready-for-use”) to this port. Operating menu setting:

APPL 2:

CHECK.WG: 4.3.

For example, you can use this function to show the weighed or measured result on a simple external indicator.

All data output ports have a high voltage level when:

- the application has not been initialized,
- the weighing instrument is not at stability and one of the “at stability...” parameters is selected
- the weight is not within the checkweighing range

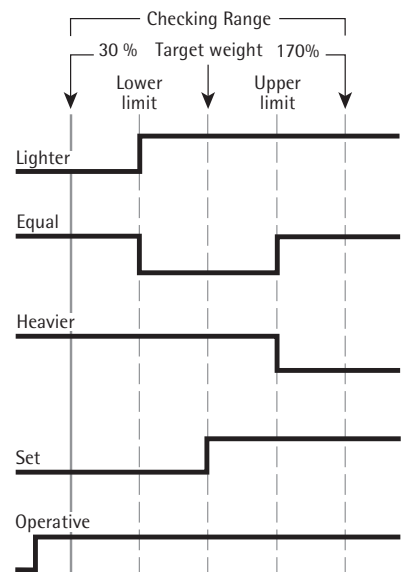

Digital Input/Output Interface

- <SET> control output: set
- Activation of port lines: always on

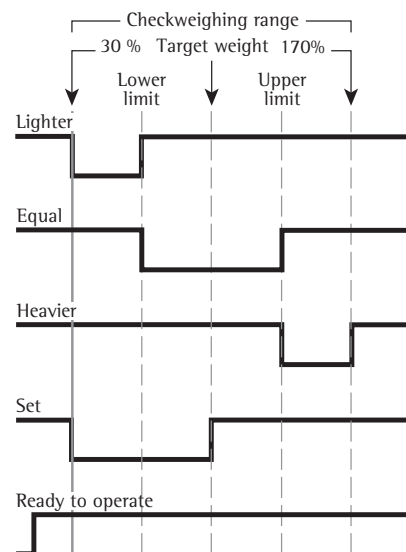

Digital Input/Output Interface

- <SET> control output: set
- Activation of port lines: within checkweighing range

Output Port Specifications

- When not in use, the voltage level is high: >3.7 V/+4 mA
- When activated, the voltage level is low: <0.4 V/-4 mA

⚠ The data outputs are not protected from short circuits.

Application: Checkweighing +/-

Example: 1

Checkweighing samples with a target weight of 1250 g and a tolerance range from -10 g to +30 g

Settings (changes in the factory settings required for this example):

Application parameters: Application: Checkweighing

Setup: Printout: *PRTPROT*: 7.6.; then select menu line item of your choice (see "Configuration" for options)

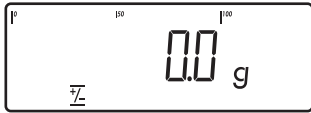

OK

- 1 Enter the initial target and tolerance limit values

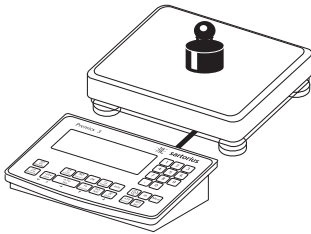

- 2 Place a sample equal to the target weight (in this example, 1250 g) on the platform

OK

- 3 Save target value



1 2 4 0

- 4 Enter value for lower limit (in this example, 1240 g)



OK

- 5 Save value for the lower limit



1 2 8 0

OK



(=)

- Signum 3 only:
- 6 Enter value for the upper limit (in this example, 1280 g)

Save value for upper limit

- 7 Weigh samples

- 8 Print the results
Note: If automatic printout of results is enabled, you do not need to press the (=) key; the results are printed automatically.

Setp	+	1.250	kg
Min	+	1.240	kg
Max	+	1.280	kg

Target
Minimum
Maximum

G#	+	1.256	kg
T	+	0.000	kg
N	+	1.256	kg

Gross weight
Tare weight
Net weight

Lim	+	0.48	%
-----	---	------	---

Percentage of deviation from target*

W.Diff+	0.006	kg
---------	-------	----

Absolute deviation from target

- * Only in "Tolerance limits" display mode:
If the weight is lighter than the target, the display shows:
LL

If the weight is heavier than the target, the display shows:
HH

Application: Checkweighing toward Zero

Example: 1

Checkweighing samples with a target weight of 1250 g and a tolerance range from -10 g to +30 g

Settings (changes in the factory settings required for this example):

Application: Checkweighing toward zero (**menu item 4.7.2**)

Setup: Printout: *PRTPROT*: 7.5.; then select menu line item of your choice (see “Configuration” for options)



1 2 8 0

6 Enter value for the upper limit (in this example, 1280 g)

OK

Save value for upper limit

OK

1 Enter the initial target and tolerance limit values



7 Weigh samples

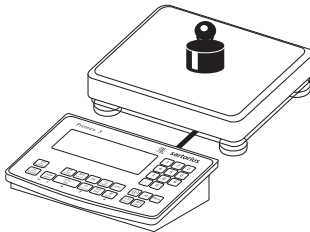

2 Place a sample equal to the target weight (in this example, 1250 g) on the platform



8 Print the results
Note: If automatic printout of results is enabled, you do not need to press the  key; the results are printed automatically.

Set p	+	1.250	kg	Target
Min	+	1.240	kg	Minimum
Max	+	1.280	kg	Maximum

OK

3 Save target value



G#	+	1.256	kg	Gross weight
T	+	0.000	kg	Tare weight
N	+	1.256	kg	Net weight

1 2 4 0

4 Enter value for lower limit (in this example, 1240 g)



Lim	+	0.48	%	Percentage of deviation from target*
W.Diff+		0.006	kg	Absolute deviation from target

* Only in “Tolerance limits” display mode:
If the weight is lighter than the target, the display shows: LL

OK

5 Save value for the lower limit







If the weight is heavier than the target, the display shows: HH

Application: Classification

With the Classification application, you can determine whether the weight of a given sample lies within the limits of a defined weight class.

Features

- Classification with 3 or 5 weight classes. Configure in the operating menu, under:
APPL 2:
CLASS: 4.8.
- Enter the upper class limits using the keypad or by saving weight values from a load on the platform
- Enter the upper limits of weight classes as absolute values or as a percentage of deviation from the upper limit of Class. Configure in the operating menu, under:
APPL 2:
CLASS: 4.9.
- Activate info-mode by pressing  (> 2 sec)
- Toggle the main display between classes and weight values by pressing .
- Automatic printout of results. Configure in the operating menu, under:
APPL 2:
CLASS: 4.10.
- Automatic taring of container weight. Operating menu setting:
APPL: A.TARE: 3.7.
- Automatic initialization when you switch on the Signum with most recently saved application data. Operating menu setting:
APPL: A.START: 3.8.
- Closing application program; deleting parameters:
You can select the function of the  key for clearing application data. When an application is active, this key can either delete the values saved for all applications, or delete selected values saved for the active application. Operating menu setting:
APPL: SEL.CF: 3.24.
(select CF key function in applications)

- Tare function:
 - 1) If you store a tare (weight value) by pressing the  key, you can later enter a tare value manually. The tare value you enter is added to the stored tare value.
Setting: menu code 3.25.1 (factory default)
 - 2) A tare value entered manually overwrites a stored tare value (weight value). If you enter a tare value manually, a tare value (weight value) stored later overwrites the manually entered value.
Setting: menu code 3.25.2
Operating menu setting:
Signum 2
APPL : #1 : 3.25.
Signum 3
APPL : TARE.F : 3.25.
- Restore factory default settings. Operating menu setting:
Signum 2:
APPL : #1 : 9.1.

Signum 3:
APPL : DEF.APP : 9.1.

To use the Classification application, you need to enter the delimiters that separate one class from another.

The lower limit of Class 1 is defined by the preset minimum load. The other classes are configured by defining their upper limits. There are two ways to enter the delimiters for classes 1 through 3 (or 5):

- By saving the weight value indicated: Each upper value, with the exception of the highest, is entered using the keypad or by saving the weight value of a load on the weighing platform.
- By entering a percentage: The upper value of Class 1 is entered using the keypad or by saving the value indicated. Upper limits for the other classes are defined by entering a percentage of deviation from the upper limit of Class 1, using the keypad. Example: Enter 100 g as the upper limit of Class 1. Then enter 15%.







When working with 3 classes, this yields the following weight classes:
Class 0: up to the minimum load
Class 1: > minimum load, up to 100 g
Class 2: >100 g to 115 g
Class 3: > 115 g, up to maximum load

When working with 5 classes, this yields the following weight classes:
Class 0: up to the minimum load
Class 1: > minimum load, up to 100 g
Class 2: >100 g to 115 g

Class 3: >115 g to 130 g
Class 4: >130 g to 145 g
Class 5: > 145 g, up to maximum load

The initial application values are valid until deleted by pressing the  key or until overwritten by new values. They also remain saved after you switch off the scale.



Preparation

- Switch on the scale: Press 
- While all segments are lit, press the  key
- Select the Application menu: Press  repeatedly until *APPL* is displayed
- Open the Application menu: Press the  key
- Select the Classification application: Press the  key repeatedly until the desired menu item is displayed and press  to open the submenu

Application Parameters: Classification

3.6.	Minimum Load for Initialization and Defining the Class 1 Lower Limit	
3.6.1*	1 digit	
3.6.2	2 digits	
3.6.3	5 digits	
3.6.4	10 digits	
3.6.5	20 digits	
3.6.6	50 digits	
3.6.7	100 digits	
3.6.8	200 digits	
3.6.9	500 digits	
3.6.10	1000 digits	
4.3.	Activate Control Line for "Set" as:	
4.3.1*	"Set" output	
4.3.2	Ready to operate (for process control systems)	
4.7.	Activation of Outputs	
4.7.1	Off	
4.7.2	Always active	
4.7.3*	Active at stability	
4.8.	Number of Classes	
4.8.1*	3 classes	
4.8.2	5 classes	
4.9.	Parameter Input	
4.9.1*	Weight values	
4.9.2	Percentage	
4.10.	Automatic Printing	
4.10.1*	Off	
4.10.2	On	

* = Factory setting

- Press  to save your settings and press  (repeatedly) to exit the operating menu.

Minimum Load

The minimum load for the first class is configured in the operating menu, under:

APPL 2:
CLASS: 3.6.

Once the limit is exceeded by the load, initialization can begin.

Once the application is initialized, a weight value below the minimum load is designated Class 0; no class is displayed.

The minimum load required for automatic taring of the container weight on the platform (“autotare first weight”), or for automatic printout of results, is configured in the operating menu, under:

APPL: M.WEIGH: 3.5.

You can choose from the following 10 levels for this setting:

- 1 digit
- 2 digits
- 5 digits
- 10 digits
- 20 digits
- 50 digits
- 100 digits
- 200 digits
- 500 digits
- 1000 digits

The “digits” here refer to the scale intervals in the connected weighing platform. If the interval of the connected platform is 1 g, for example, and 1000 digits are required, you must place at least 1000 g (=1000 intervals =1000 digits) on the weighing platform for the first class to activate autotaring or autoprint.

Display

The result of a given measurement is shown as either a weight value or the class number.

- Weight display
The current weight is shown in the measured value line and the current class in the text line.
- Display of classes
The current class is shown in the measured value line, and the current weight in the text line.

Digital Input/Output Interface

The Classification application supports the digital input/output-interface.

There are 4 control lines, or outputs, which are activated as follows (see also the diagram on the right):

- With 3 classes:
 - Class 1
 - Class 2
 - Class 3
 - Set
- With 5 classes:
 - Classes 1/2
 - Classes 2/3/4
 - Classes 4/5
 - Set

In the operating menu, under:

APPL 2:
CLASS: 4.7.

you can define whether these control ports are

- off,
- always on,
- activated at stability,

The “SET” output normally changes its voltage level when the current weight exceeds the minimum load. Alternatively, you can assign the “Operative” function (indicating “Ready-for-use”) to this port.

Operating menu setting:
APPL 2:
CLASS: SECTION 4.3.

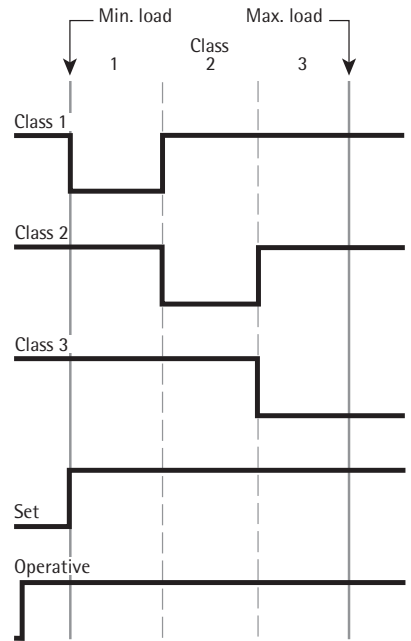

Digital Input/Output Interface Control lines when working with 3 classes

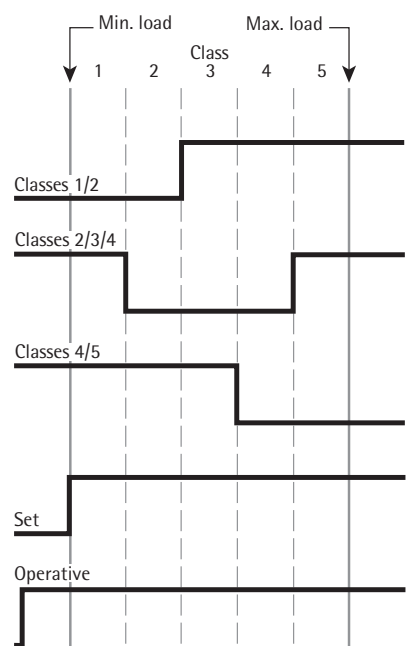

Digital Input/Output Interface Control lines when working with 5 classes

Application: Classification

Example:

Defining three classes.

Settings (changes in the factory settings required for this example):

Applications: application 2: Classification

Setup: Printout: *PRTPROT*: 7.6.; then select the menu line item of your choice (see "Configuration" for options)

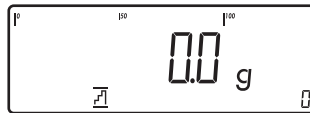
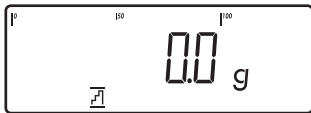

OK

1 Begin input of class delimiters

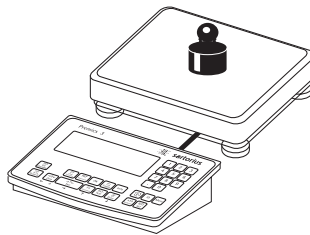

6 Place the sample on the weighing platform

1 1 0

Signum 3 only:
2 Enter the upper limit for Class 1 via the keypad (in this example, 0.110 g)



Read the result

OK

3 Save the upper limit for Class 1



7 Print the result
Note: If automatic printout of results is enabled, you do not need to press the  key; the results are printed automatically.

1 3 0

Signum 3 only:
4 Enter the upper limit for Class 2 via the keypad (in this example, 0.130 g)

Lim1 + 0.110 kg
Lim2 + 0.130 kg

Configured printout:
see page 81

OK

5 Save the upper limit for Class 2

G# + 0.118 kg
T + 0.000 kg
N + 0.118 g

class 2

Application: Totalizing Σ

With the Totalizing application, you can add weight values together in the totalizing memory. In addition to weight values, the quantity of individual values added to memory is also saved (transaction counter).

Features

- Totalize up to 999 individual weights

Save values automatically:

- Save both net values and calculated values (if available). Configure in the operating menu, under:

APPL 3:
TOTALIZ: 3.16.

- Save weight values and calculated values from either Application 1 (for example, Counting, Weighing in Percent) or Application 2 (Checkweighing). Operating menu setting:
APPL 3:
TOTALIZ: 3.22.

- Current transaction number displayed in the text line (indicating the items already added)

- Weighing in up to a defined target, with the totalization memory content + current weight displayed in the text line.

- Save weight values manually or automatically

- Accurate calculation of total of weight values from two weighing platforms

- Activate info-mode by pressing **[Info]**

- Automatic printout when value saved

- Automatic taring of container weight.
Operating menu setting:
APPL: A.TARE: 3.7.

- Incomplete totalizing routines saved in battery-backed memory.
Operating menu setting:
APPL: A.START: 3.8.

- Closing application program; deleting parameters:
You can select the function of the **[CF]** key for clearing application data. When an application is active, this key can either delete the values saved for all applications, or delete selected values saved for the active application.
Operating menu setting:
APPL: SEL.CF: 3.24.
(select CF key function in applications)

- Tare function:
1) If you store a tare (weight value) by pressing the **[T+]** key, you can later enter a tare value manually. The tare value you enter is added to the stored tare value.
Setting: menu code 3.25.1 (factory default)
- 2) A tare value entered manually overwrites a stored tare value (weight value). If you enter a tare value manually, a tare value (weight value) stored later overwrites the manually entered value.
Setting: menu code 3.25.2
Operating menu setting:
Signum 2
APPL : Σ : 3.25.
Signum 3
APPL : TARE.F : 3.25.

- Restore factory default settings. Operating menu setting:
Signum 2:
APPL : Σ : 9.1.

Signum 3:
APPL : DEFAPP : 9.1.

The Signum has a totalizing memory for adding individual net and gross values. You can save weight values in totalizing memory manually or automatically. Configure in Setup under:
APPL 3:
TOTALIZ: 3.16.

- Add a weight value manually by pressing **[OK]**
The net value from the active platform is added to the value already saved in totalization memory and the transaction counter value is increased by one. When a value is added manually, the program does not check whether the platform has been unloaded since the last time the **[OK]** key was pressed.
- Value saved automatically when the weighing platform is stable and the defined minimum load is exceeded. If the defined minimum load is not exceeded, you can save the item manually by pressing the **[OK]** key. Regardless of these settings, the current value cannot be saved automatically unless the platform had been unloaded before the current sample was placed on it. The weighing platform is considered to be unloaded when the load less than 50% of the minimum load.

The number of items added to memory is displayed in the text line.

Press the **[CF]** key to clear the totalizing memory. A printout is automatically generated.

With the weighing platforms connected, you can add values from both platforms to the totalizing memory.

The displayed result is accurately calculated in the active weight unit. Example: When you add 1243 g (determined on a weighing platform with three decimal places) to 1400 g (determined on a platform with 1 decimal place) the display shows 2.643 g.

Application: Totalizing Σ

Preparation

- Switch on the scale: Press ON
- While all segments are lit, press the ←T→ key
- Select the Application menu: Press Fn repeatedly until *APPL* is displayed
- Open the Application menu: Press the ←T→ key
- Select the Totalizing application: Press the Fn key repeatedly until the desired menu item is displayed and press ←T→ to open the submenu

Application Parameters: Totalizing

3.6.	Minimum Load for Automatic Storage/Transfer of Values
3.6.1*	1 digit
3.6.2	2 digits
3.6.3	5 digits
3.6.4	10 digits
3.6.5	20 digits
3.6.6	50 digits
3.6.7	100 digits
3.6.8	200 digits
3.6.9	500 digits
3.6.10	1000 digits
3.16.	Automatic Storage
3.16.1*	Off
3.16.2	On
3.17.	Automatic Individual or Component Printout when Value Stored
3.17.1	Off
3.17.2*	Generate printout with complete standard configuration each time OK is pressed
3.17.3	Generate printout with complete standard configuration only once when OK is pressed
3.22.	Source of Data for Values Saved Automatically
3.22.1*	Application 1
3.22.2	Application 2
3.23.	Value(s) to be Saved
3.23.1*	Net
3.23.2	Calculated
3.23.3	Net and calculated

* = Factory setting

Minimum Load

The minimum load required for automatic taring of the container weight on the platform (“autotare first weight”) is configured in the operating menu, under:
APPL: M.WEIGH: 3.5.

The minimum amount that a component must weigh before it can be saved in totalizing memory is configured in the operating menu, under:

*APPL 3:
TOTALIZ: 3.6.*

You can choose from the following 10 levels for this setting:

- 1 digit
- 2 digits
- 5 digits
- 10 digits
- 20 digits
- 50 digits
- 100 digits
- 200 digits
- 500 digits
- 1000 digits

The “digits” here refer to the scale intervals in the connected weighing platform. If the interval of the connected platform is 1 g, for example, and 1000 digits are required, you must place at least 1000 g (=1000 intervals =1000 digits) on the weighing platform for autotaring (only with the “Autotare first weight” option selected).

Data Record or Printout

In the operating menu, under:

*APPL 3:
TOTALIZ: 3.17.*

you can configure whether a printout is generated manually, by pressing F1 , or automatically when a weight value is saved in the totalizing memory. If you select *3.17.1* for this setting, printouts can be generated only manually, by pressing F1 (individual printout). If you select *3.17.2* (printout of a component on request), the full printout is generated every time the “Print” key is pressed.

The total data record is printed when you clear the totalizing memory (by pressing the CF key).

- Press ←T→ to save your settings and press ←0→ (repeatedly) to exit the operating menu.

Example:

Totalizing weight values.

Settings (changes in the factory settings required for this example):

Application parameters: Application: Totalizing

Setup: Printout: *PRTPROT: 7.6.*

Setup: "Print when value stored"; then select menu line items of your choice (see the chapter entitled "Configuration," under "Printouts," page 34)

Setup: Printout: "Total printout: Print when CF pressed;"

then select the menu line items of your choice (see "Configuration" for options)

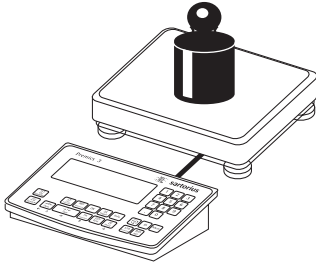

1 Place the first weight on the weighing platform

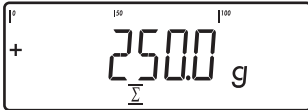

Weight value is displayed

OK

2 Save the first weight value in totalizing memory

G#	+	0.250	kg
T	+	0.000	kg
N	+	0.250	kg
n		1	

The component data is printed automatically (configured printout)

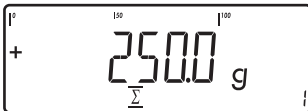

The transaction counter value is increased by 1.

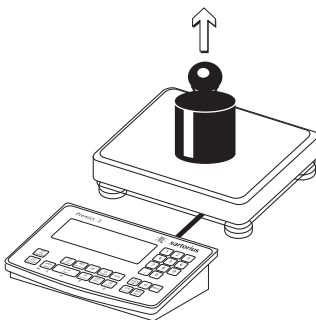

3 Remove the first weight from the weighing platform

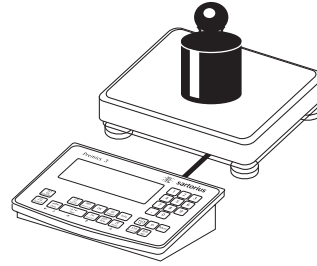

4 Place the second weight on the weighing

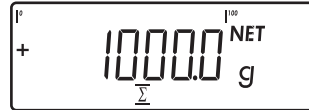

Weight value is displayed

OK

5 Save the second weight value in totalizing memory

G#	+	1.346	kg
T	+	0.346	kg
N	+	1.000	kg
n		2	

The component data is printed automatically (configured printout)

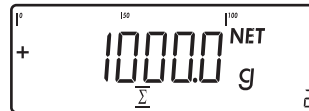

The transaction counter value is increased by one, to "2"

↺

6 Toggle the display between individual and total value

CF

7 End totalizing



*G	+	1.346	g
*N	+	1.250	g
n		2	

The total data record is printed as configured.

Application: Net-total Formulation ↓

With the Net-total Formulation application, you can weigh in different components up to a defined total. Each component is saved in a net-total memory.

Features

- Weigh in up to 999 components in series
- Net-total formulation cannot be combined with a level 1 or level 2 application
- Current component number displayed in the text line (indicating the component to be added)
- Toggle the display between “component mode” and “additive mode” by pressing .
 - Component mode: Display the weight of the component currently on the platform (for 1 second after it is saved; then the platform is tared)
 - Additive mode: Display the weight of all components on the platform (after it is saved, the net weight of the last component added is displayed briefly)
- Toggle to a second weighing instrument while weighing on the first
- Activate info-mode by pressing 
- Automatic printout each of component as it is saved. Configure in the operating menu, under:
APPL 3:
NET TOT: 3. 17.

If menu item 3. 17.2 is set, the entire component printout is generated every time a component is saved. If menu item 3. 17.3 is set, the full printout is generated only once, for the first component:
Blank line, date, time, ID1 through ID4, header lines 1 and 2. For subsequent components, each “component” item (“Comp xx”) is followed by a blank line.

- Automatic taring of container weight.
Operating menu setting:
APPL : A.TARE: 3. 7.
- Restore factory default settings.
Operating menu setting:
Signum 2:
APPL : ↓ : 9. 1.

Signum 3:
APPL : DEF.APP: 9. 1.

Preparation

- Switch on the scale: Press **[ON]**
- While all segments are lit, press the **[←T→]** key
- Select the Application menu: Press **[Fn]** repeatedly until *APPL 3* is displayed
- Open the Application menu: Press the **[←T→]** key
- Select the Net-total Formulation application: Press the **[Fn]** key repeatedly until the desired menu item is displayed and press **[←T→]** to open the submenu

Application Parameters:
Net-Total Formulation

3.6.	Minimum Load for Automatic Storage/Transfer of Values
3.6.1*	1 digit
3.6.2	2 digits
3.6.3	5 digits
3.6.4	10 digits
3.6.5	20 digits
3.6.6	50 digits
3.6.7	100 digits
3.6.8	200 digits
3.6.9	500 digits
3.6.10	1000 digits
3.17.	Automatic Individual or Component Printout when Value Stored
3.17.1	Off
3.17.2*	Generate printout with complete standard configuration each time [OK] is pressed
3.17.3	Generate printout with complete standard configuration only once when [OK] is pressed

* = Factory setting

- Press **[←T→]** to save your settings and press **[→0←]** (repeatedly) to exit the operating menu.

Minimum Load

The minimum amount that a component must weigh before it can be saved in net-total memory is configured in Setup under:

APPL 3
NET TOT: 3.6.

Once the limit is exceeded by the load, the value can be saved. If the load is too light, the following will occur when you try to save a value:

- The error code *INF 29* is displayed
- The weighing platform is not initialized

The minimum load required for automatic taring of the container weight on the platform ("autotare first weight") is configured in Setup under:

APPL: M.WEIGH: 3.5.

You can choose from the following 10 levels for this setting:

- 1 digit
- 2 digits
- 5 digits
- 10 digits
- 20 digits
- 50 digits
- 100 digits
- 200 digits
- 500 digits
- 1000 digits

The "digits" here refer to the scale intervals in the connected weighing platform. If the interval of the connected platform is 1 g, for example, and 1000 digits are required, you must place at least 1000 g (=1000 intervals =1000 digits) on the weighing platform for initialization.

Net-total Formulation with Two Weighing Platforms

This mode is used for weighing large and small components at the same time.

In this mode, you can toggle from the small-component instrument to the large-component instrument during measurement. Once you toggle to the large-component instrument, the **[→0←]** and **[←T→]** keys are available until a component value is saved. For example, you can take a partially-filled container from the small-component instrument and tare it on the large component instrument.

The value in component memory on the small-component instrument is transferred to the large-component instrument and the weight unit is converted, if necessary. The Component and Additive display modes are both available on the large-component instrument.

The value read by the active instrument is saved in component memory. The displayed result is accurately calculated in the active weight unit.

When you press **[CF]** to stop a measurement series, the tare memories for both platforms are cleared, unless the large-component instrument is in SBI mode, in which case the instrument is only tared.

Application: Net-total Formulation ↓

Example:

Weighing in 3 components of a formulation recipe.

Settings (changes in the factory settings required for this example):

Application parameters: Application: Net-total formulation

Setup: Printout: *PRTPROT*: 7.6. "Component printout: Print when value stored;" then select the menu line item of your choice (see "Configuration" for options)

Setup: Printout: *PRTPROT*: 7.6.: "Total printout: Print when CF pressed;" then select the menu line item of your choice

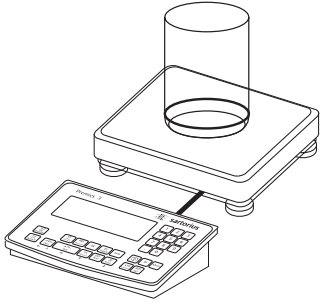

- 1 Place empty container on the platform



- 2 Tare the scale

Note: If the automatic tare function is enabled, you do not need to press the  key to tare the scale; the tare weight is saved automatically when you place the container on the platform

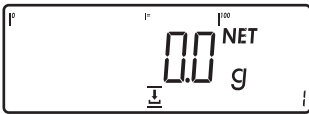

Prompt to fill and save the first component is shown

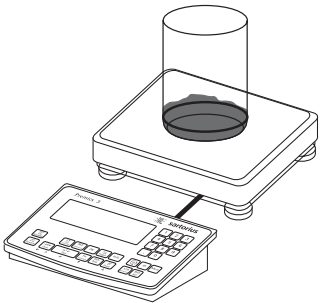

- 3 Add the first component to the container (in this example, 1100 g)

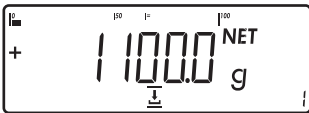

The weight of the first component is displayed



- 4 Store the weight of the first component

Cmp001+ 1.100 kg The component weight is printed automatically



The weighing platform is tared and the component counter value is increased by one. Prompt to fill and save the second component is shown.

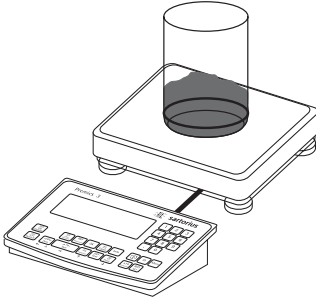

5 Add the second component to the container (in this example, 525 g)



The weight of the second component is displayed



6 Store the weight of the third component

Cmp002+ 0.525 kg

The component weight is printed automatically

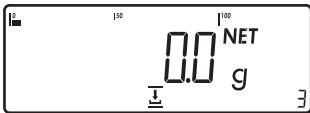

The weighing platform is tared and the component counter value is increased by one. Prompt to fill and save the third component is shown.



7 Toggle to the “additive mode” to view the total weight of all components.



The value displayed equals the weight of all components added up to now plus the current weight.

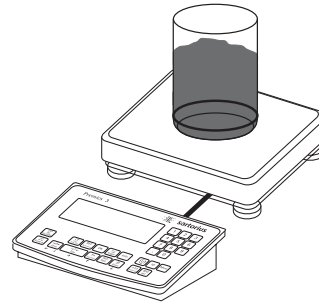

8 Add the third component to the container, bringing the total up to the desired target (in this example, 2000 g).

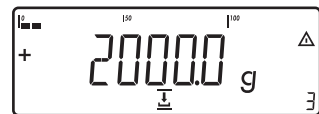

The total weight is displayed



9 Store the weight of the third component

Cmp003+ 0.375 kg

The component weight is printed automatically



The component counter value is increased by one. Prompt to fill and save a fourth component is shown



10 End weighing-in operation

Results are printed automatically (configured total printout)

n + 3
Tot.cpt+ 2.000 kg
Cont.T+ 0.296 kg

Number of components
Contents of component memory
Contents of tare memory (container weight)

Examples of Application Combinations in Signum 3

Example 1: "Breaking bulk" (Counting, Checkweighing and Totalizing)

Settings (changes in the factory settings required for this example):

Setup: Application 1: Counting (COUNT)

Setup: Application 2: Checkweighing (CHECK.WG)

Setup: Application 3: Totalizing: Value saved: Net + calculated (3.23.3)

Setup: Application 3: Totalizing: Autosave: On (3.16.2)

Setup: Application 3: Totalizing: Source of data: Application 2 (3.22.2)

Setup: Printout, *PRTPROT*: 7.8. "Configuration list, total"; then select the menu line items of your choice

"Total printout: Print when  pressed;" then select the menu line items of your choice (X.X.X) (see "Configuration" for options)



1 Switch on the scale and configure as described above



2 Delete any data from previous operation

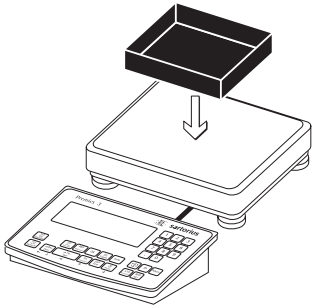

3 Place empty container on the platform



4 Tare the scale

Note: If the automatic tare function is enabled, you do not need to press the  key to tare the scale; the tare weight is saved automatically when you place the container on the platform

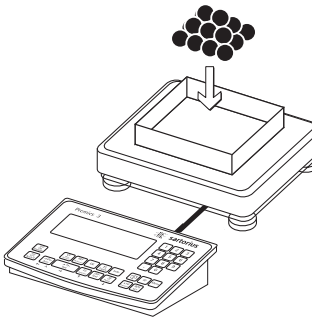
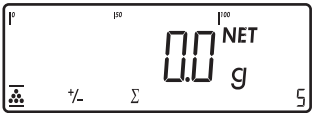

5 Place a number of parts in the container for the reference quantity (in this example, 10 pcs)



6 Activate calculation of the reference sample weight

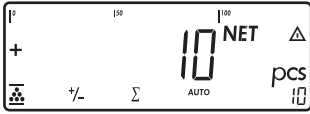

If the weight is too light, the error code *INF 29* is shown in the main display.

Reduce the minimum load setting or increase the reference sample quantity and the number of parts in the container.



7 Toggle to Checkweighing

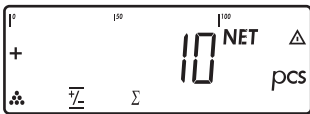

8 Initialize Checkweighing

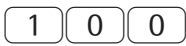

9 Enter target value, minimum and maximum (in this example, target 100 pieces, minimum 100 pieces, maximum 102 pieces)

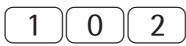
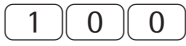

10 Toggle to Totalizing

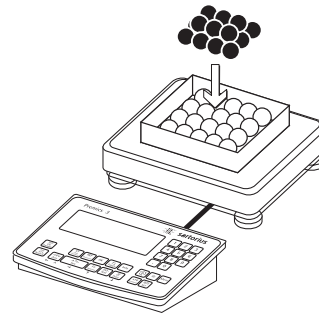
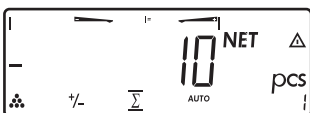

11 Add desired number of pieces

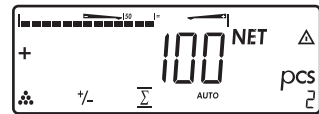

The number of pieces is saved automatically

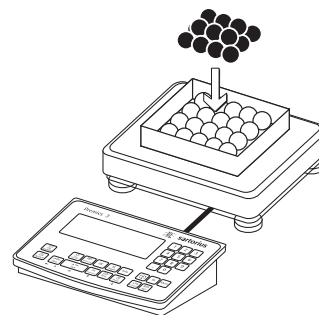

13 Perform further counting operations as desired

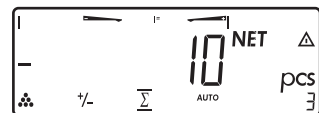

14 Toggle display from individual value to total



15 End the "breaking bulk" operation and print the final evaluation

nRef	+	10	pcs
wRef	+	0.001000	kg
Setp	+	100	pcs
Min	+	100	pcs
Max	+	102	pcs

n		6	
*N	+	0.600	kg
Total	+	600	pcs

Configured printout
Total

Product Data Memory in Signum 3

Purpose

The product data memory stores initialization data and user data (product and tare values).

Features

- The product data memory has 100 memory cells for product or tare values
 - For example, you can store 80 sets of application data and 20 tare values

- Each memory cell is unambiguously identified by a number of up to four digits

- The product data memory can be used with the following applications:

Application level 1:

- *WEIGH.*
- *COUNT.*
- *NEUTRM*
- *ANIM.WG*
- *PERC.WG*

Application level 2:

- *CHECK.WG*
- *CLASS.*

- Data records can be created, overwritten and individually deleted
- Data remains stored when scale is switched off

Functions

Storing base data (in this example, in the Counting application):

- Initialize the application.
- Enter a memory cell number and press and hold the **Mem** key (at least 2 seconds).

Storing tare values:

- Store tare data in PT.
- Enter a memory cell number and press and hold the **Tare** key.

Loading stored product or tare values:

- Enter a memory cell number and press the **Mem** key for >2 sec.

View information on a particular product or tare value:

- Enter a memory cell number and press the **Info** key.
- To toggle between *wREF* (average piece weight) and *nREF* (quantity), press **Fn**.
- Press the **→T←** key to scroll the display to the right.
- Press the **→T←** key to activate the displayed value.
- To clear the displayed memory cell (delete data), press and hold **CF**.
- Press the **→T←** key to exit the product data memory mode.

To view information on all product and tare memory data:

- Press the **Mem** key; the lowest memory cell number is displayed.
- Press the **→T←** key to scroll through cell numbers in lexical order (e.g., 1, 3, 333, 4, etc.).
- Press the **Mem** key, to activate the selected memory cell.
- Press the **Info** key to view the stored product values.
- Press and hold **CF** to delete the data in the selected memory cell.
- Press the **Info** key to exit the product memory mode.

To clear a particular memory cell:

- Enter the memory cell number and press the **CF** key.

Example:

Using the Counting application with a stored average piece weight. Settings (changes in the factory settings required for this example):
Application parameters: Application:
COUNTING

Storing the average piece weight:

- Initialize the application.
- Determine the average piece weight using one of the methods described above.
- Enter the memory cell number using the keypad and press and hold the **Mem** key.

Loading the average piece weight or reference sample quantity:

- Enter memory cell number and press the **Info** key.
- To toggle between *wRef* (average piece weight) and *nRef* (quantity), press **Fn**.
- Press the **→T←** key (repeatedly, if desired) to scroll the display to the right.
- Press the **→T←** key to activate the displayed value.
- To clear the displayed memory cell (delete data), press and hold **CF**.
- Press the **→T←** key to exit the product data memory mode.

Overwriting data in a memory cell:

- To store a new average piece weight in a memory cell already in use, enter the desired memory cell number using the keypad and press and hold the **Mem** key. The previous average piece weight is overwritten.
- To cancel input without saving the new value, press the **CF** key.

Deleting the average piece weight:

- Enter the number of the memory cell in which the average piece weight is stored and press **Info**.
- To delete the displayed value, press and hold **CF**.

Configuring Printouts

Purpose

You can specify which data items are included in printouts. When using the Totalizing or Net-total formulation application, you can also define which parameters are included in the "Total" data record when the **[CF]** key is pressed.

In the Setup menu under "Printout" you can configure an individual, component or total data record that contains all data items activated for the application program currently in use. The printout should be formatted only after the desired application has been configured, as some of the positions are application-dependent.

Features

- Quantity and content of data record lists:
 - 6 lists, each with a length of up to 30 data items
 - Individual printout, printer 1
 - Component printout, printer 1
 - Total printout, printer 1
 - Individual printout, printer 2
 - Component printout, printer 2
 - Total printout, printer 2
- You can configure individual, component and total printouts separately (depends on model)
- Generate an individual printout: Press **[E]**
Automatic printout from application when active in operating menu:
 - Animal weighing/averaging
 - Checkweighing
 - Classification
- Signum 2 and 3 only:
 - Generate component printout: Totalizing/Net-total formulation: Press **[OK]** (Application parameters: Application: Totalizing: Printing: Component printout)
- Signum 2 and 3 only:
 - Generate total printout: For Totalizing or Net-total application; press the **[CF]** key
- When you change application programs in Setup, the application-specific data record lists are deleted. Other data record lists remain stored.
- You can delete individual items from the list: press and hold the **[⇨0⇩]** key
- "Form feed" item in the printout footer: For advancing to the start of the next label in print mode "YDP011S: Label" or "YDP041S: Label: Manual form feed"
- ISO/GMP-compliant printout: The Setup menu configuration under "ISO/GMP-compliant printout" is also active for configured printouts.

Preparation

- Switch on the scale: Press **[I/O]**
- While all segments are lit, press the **[⇨T⇩]** key
- Select the Setup menu: Press **[Fn]** repeatedly until Setup is displayed
- Open the Setup menu: Press the **[⇨T⇩]** key
- Press **[Fn]** repeatedly until *PRTPROT* is displayed
- Press the **[⇨T⇩]** key

PRTPROT (Printout)

7	7.4	Header and ID header input
	7.5	Quantity, interface 1
	7.6	Standard, interface 1
	7.7	Component, interface 1
	7.8	Total, interface 1 (Signum 2 and 3 only)
	7.9	Quantity, interface 2
	7.10	Standard, interface 2
	7.11	Component, interface 2
	7.12	Total, interface 2 (Signum 2 and 3 only)
	7.13	ISO/GMP data record
	7.14	Date with/without time
	7.15	Automatic printout after stability
	7.16	Flex Print
	7.17	Decimal separator
9	9.1	Factory settings

- Save settings and exit operating menu: Press **[⇨0⇩]** repeatedly

Additional Functions

- Printing the "Selection" and "List" Settings
 - *LIST*: Print the currently selected list
 - *SELECT*: Print the items available for selection
- When the highlight bar is in the *LIST* or *SELECTION* column: Press the **[E]** key

> Printout (example):

```

Indiv.Prt
List
=====
Net
Gross
Tare
Tare 2
Pieces
=====
etc.
```

Example:

Standard printout for data output from the Counting application

Settings (changes in the factory settings required for this example):

Application parameters: Application: Counting

Then set the printing option: Printout: Interface 1: Print when (Fn) key pressed

- Select the Setup menu: Press (Fn) repeatedly until *SETUP* is displayed
- Open the Setup menu: Press the (→T←) key
- Press (Fn) repeatedly until *PRTPROT* is displayed
- Press the (→T←) key



1 Press (→T←) repeatedly until 7.4 is displayed



2 Press (Fn) repeatedly until 7.5 is displayed



3 Press the (→T←) key; the list of print items is displayed



4 Press the (→T←) key again to open the list of available items



The first item in the list is shown



5 Press the (→T←) key to select the print item displayed and add it to the list of print items.

or



6 Press the (Fn) key to scroll through the list of available items. To view the list of all available items, see the menu printed on pages 34–35 of this manual.



7 Press (Fn) repeatedly until ----- is displayed

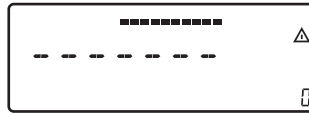

8 Press the (→T←) key to add the selected item



9 Press (Fn) repeatedly until *REF.WT.* is displayed



10 Press the (→T←) key to add the selected item

11 Follow the same procedure to add other print items as desired; to delete an individual print item, press and hold the (→0←) key.



12 To conclude selection of print items, press (→0←) repeatedly until *APPL* is displayed



13 Press and hold (→T←) (2 to 3 seconds) to return to weighing mode

14 Perform weighing operations as desired and then print the results



15 Press the (Fn) key to print results.

```
-----
nRef          5 pcs
Qty           8 pcs
wRef    + 0.4000 g
```

Example of a printout

Interface Port

For COM1 (25-pin D-Sub female connector)

COM1	All Signum models	Signum 2 and 3 only
Standard: RS-232 SBI/XBPI protocol	Computer with serial RS-232 input port Printers: YDP04IS YDP02IS YDP12IS YDP03-OCE External Alibi memory: YAM01IS External Bluetooth adapter: YBT01 Second display: YRD02Z USB adapter cable for connecting a computer over USB: YCC01IS Digital in (TTL/ 5V)	Red-green-red display YRD14Z (uses digital control lines) Digital control lines (TTL/ 5V) <;=;set;> to relay box YSB01 Additional digital platform with RS-232 interface Additional weighing instrument with SMA/XBPI protocol
Option A31: "clock" RS-232 connector	As with the standard RS-232 interface, but includes date/time	
Universal in: print/ tare	Print/tare key function	

For UniCOM

Male connector: for RS-232/ RS-422/ RS-485 analog output port/ digital I/O: 25-pin D-Sub female connector Ethernet: RJ45 socket Profibus: D-Sub 9 female connector UniCOM (can be selected optionally)	
RS-232 Option A1, YD001SW-232	<ul style="list-style-type: none"> - Computer with serial RS-232 input port, SBI/XBPI protocol - External Alibi memory: YAM01IS - External Bluetooth adapter: YBT01 - Second display: YRD02Z - USB adapter cable for connecting a computer over USB: YCC01-USBM2 - Second weighing point: scale with RS-232 data output - Second weighing point: IS platform with optional RS-232 data output - Second weighing point for analog platform (e.g., Combics CAP.. platform) over YCO02IS-OCE transmitter
RS-422 Option A25, YD001SW-485/422	Point-to-point connection with SBI/XBPI or SMA protocol
RS-485 Option A3, YD001SW-485/422	Network, up to 32 weighing instruments over XBPI bus Additional IS platform with standard RS-485 data output
Analog output port option A9, YD001SW-A0	Controllers with analog input
Dig. 5 In/5 OUT: Option A5, YD001SW-DIO	For connecting the Signum scale to controllers Digital IN: Voltage: 0-30V DC; current: 1 to 2 mA Digital OUT: Voltage: >30V DC; current: 100 mA For specific signals, please refer to the detailed descriptions of the options
Ethernet: Option B9, YD001SW-ETH	Office or production area network
Profibus: Option B1, YD001SW-DP	Connect devices over Profibus DP field bus

Connecting a Second Weighing Platform

On Signum 2 and 3 models, you can connect a second weighing platform to either the COM1 or the UniCOM port.

COM1 operates in RS-232 mode. A second weighing instrument on this port can use the following operating modes:

- SBI
- XBPI-232 (factory setting)
- ADC-232

UniCOM can operate in either the RS-232 mode or in RS-485 mode.

A second weighing instrument on this port can use the following operating modes:

- SBI (RS-232 mode)
- XBPI-232 (RS-232 mode)
- ADC-232 (RS-232 mode)
- IS-485 (RS-485 mode, XBPI mode; factory setting)
- ADC-485 (RS-485 mode)
- Second A/D converter using additional interface (menu: comspec)

Pin Assignment Chart

Female connectors COM1 and UniCOM:

25-pin D-Submini female connector (DB25S) with screw lock hardware

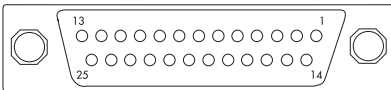

Front view

Male interface connector used (please use connectors with the same specifications):

25-pin D-Submini (DB25) with integrated shielded cable clamp assembly (Amp type 826 985-1C) and fastening screws (Amp type 164868-1)

Pin Assignments in COM1

- Pin 1: Shield
- Pin 2: Data output (Tx/D)
- Pin 3: Data input (Rx/D)
- Pin 4: Internal ground (GND)
- Pin 5: Clear to send (CTS)
- Pin 6: Not connected
- Pin 7: Internal ground (GND)
- Pin 8: Internal ground (GND)
- Pin 9: Not connected
- Pin 10: Not connected
- Pin 11: +12V for printers
- Pin 12: RES_OUT\
- Pin 13: +5V (on/off for bar code scanner)
- Pin 14: Internal ground (GND)
- Pin 15: Universal remote switch
- Pin 16: Control output "lighter"
- Pin 17: Control output "equal"
- Pin 18: Control output "heavier"
- Pin 19: Control output "set"
- Pin 20: Data terminal ready (DTR)
- Pin 21: Power supply ground (GND)
- Pin 22: Not connected
- Pin 23: Not connected
- Pin 24: Power supply +15 to 25 V (peripherals)
- Pin 25: +5 V



Pin Assignments in UniCOM: RS-232

Connection of external rechargeable battery and bar code scanner¹⁾ (optional UniCOM interface not installed)

- Pin 1: Shield
- Pin 2: Tx/D / *
- Pin 3: Rx/D / *
- Pin 4: Internal ground (GND)
- Pin 5: CTS / *
- Pin 6: Not connected / *
- Pin 7: GND / *
- Pin 8: GND / *
- Pin 9: Not connected / *
- Pin 10: Not connected / *
- Pin 11: +12V for printers
- Pin 12: RES_OUT\
- Pin 13: +5V switch
- Pin 14: Internal ground (GND)
- Pin 15: Universal remote switch
- Pin 16: Control output "lighter"
- Pin 17: Control output "equal"
- Pin 18: Control output "heavier"
- Pin 19: Control output "set"
- Pin 20: Data terminal ready (DTR)
- Pin 21: LINE_1 _GND
- Pin 22: LOW_BATT²⁾
- Pin 23: BATT_ON_OFF³⁾
- Pin 24: LINE_1_B
- Pin 25: +5 V

* Pin assignments depend on the UniCOM used

¹⁾ Signum 2 and 3 only

²⁾ Signal from battery pack: battery empty

³⁾ Switch off battery pack when weighing instrument is switched off

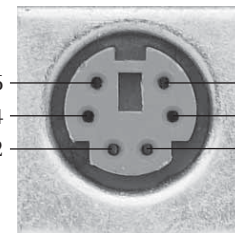

Pin Assignment for PS2 Socket:

- Pin 1: Keyboard data (data line)
- Pin 2: Not connected
- Pin 3: GND (ground)
- Pin 4: +5 V (e.g., bar code scanner)
- Pin 5: Keyboard clock
- Pin 6: Not connected

Interface Port

Cabling Diagram (Adapter Cable for PC)

Display and control unit

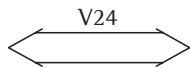
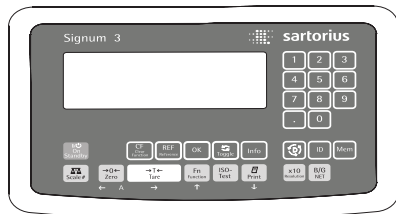

Computer

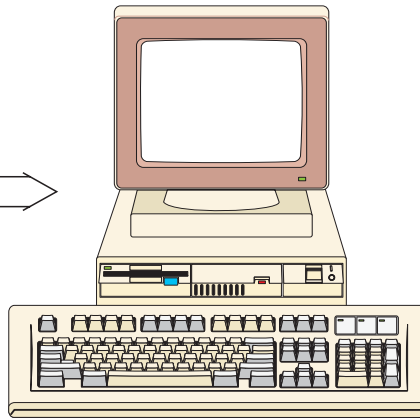

Balance/scale
25-pin
male connector

Computer,
9-contact
female connector

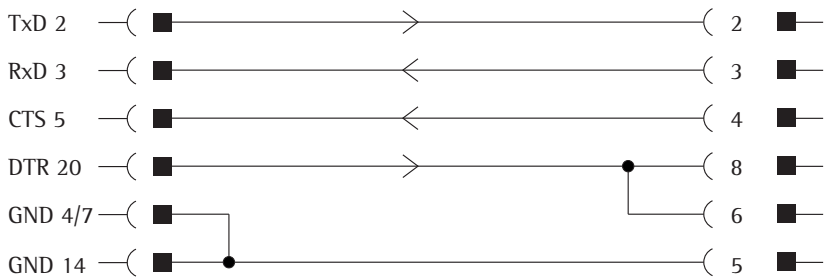

Balance/scale
25-pin
male connector

Computer,
25-contact
female connector

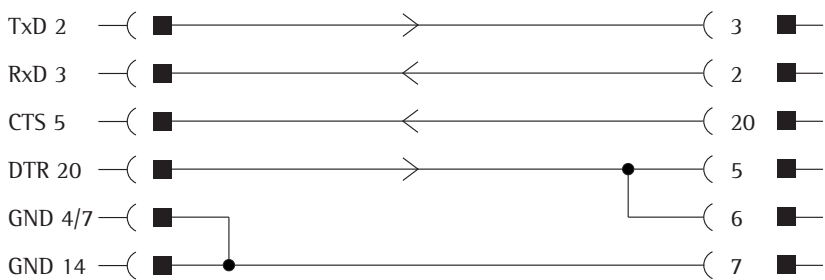

Cable type: AWG 24 specification

Configuring the Data Interface as a COM Port (DATPROT)

Configure the interface as a COM port in the operating menu under COM1 or UniCOM, under the “Data Protocol” (DATPROT) menu item.

SBI Communication

This is a simple ASCII interface. Data output is configured under menu items 6.1 and 6.3:

- Manual output of displayed value with or without stability (menu items 6.1.1 and 6.1.2)
- Automatic output of displayed value with or without stability (menu items 6.1.4 and 6.1.5) at intervals defined by display updates. The number of display updates comprising an output interval is configured under menu item 6.3.
- Output of a configurable printout. Output is linked to the “Printouts” menu item (PRTPROT) (see page 91, “Configuring Printouts;” for details on operating menu settings, see pages 34–35.

If you do not activate and configure a user-definable data record, the printout simply contains the current value displayed on the display and control unit (weight with unit, calculated value, alphanumeric display).

SMA Communication

Standardized communications protocol of the Scale Manufacturers Association

MP8 Binary (as of mid-2007)

Purpose

With the MP8 interface you can connect MP8-generation peripheral devices with separate power supplies to the Signum display and control unit.

Features

- The weighing instrument is used only for determining weight values.
- The data interface transmits only in MP8 binary protocol
- The application program for MP8 can be selected under menu item 3
- The program index 2 for MP8 can be selected under menu item 4.
- “MP8 interface emulation” is not permitted in legal metrology.

Data Input Format (Commands)

You can connect a computer to your scale to send commands controlling weighing instrument functions and applications via the interface port.

All commands use the same data input format, starting with the ESC character (ASCII 27) and ending with a carriage return (CR; ASCII 13) and a line feed (LF; ASCII 10). The total length of a command can be anywhere from 4 characters (1 command character between the start and end described above) to 7 characters (4 command characters).

The table below shows the available command characters; each command must be flanked by the start and end characters described above.

Example: The command character for output is “P” (“output to Port”). The string “ESC P CR LF” triggers this command.

Command	Meaning
K	Weighing mode 1
L	Weighing mode 2
M	Weighing mode 3
N	Weighing mode 4
O	Block all keys
P	Output readout to data interface
Q	Emit acoustic signal
R	Release (unblock) keys
T	Tare and zero (combination tare function)
f3_	Zero (see also the “kZE_” command)
f4_	Tare without zeroing (see also the “kT_” command)
kF1_	F1: Trigger (Fn) key function
kF2_	F2: Trigger (CF) key function (Signum 2 and 3 only)
kF3_	F3: Trigger (REF) key function (Signum 2 and 3 only)
kF4_	F4: Trigger (OK) key function (Signum 2 and 3 only)
kF5_	F5: Trigger (S) key function (Signum 2 and 3 only)

Command	Meaning
kF6_	F6: Trigger (Info) key function (Signum 2 and 3 only)
KF7_	(ID) key (Signum 3 only)
KF8_	(D) key (Signum 3 only)
KF9_	(Mem) key (Signum 3 only)
kCF_	CF: Trigger (CF) key function (Signum 2 and 3 only)
kP_	Trigger (E) key function Output to printer port
kT_	Trigger (T) key function (tare)
kNW_	Trigger (AA) key function (toggle the weighing instrument)
kZE_	Trigger (00) key function (zero the instrument)
x1_	Output model designation of active weighing instrument. Example: “LP6200S-0C ”
x2_	Output serial number of active weighing instrument. Example: “0012345678 ”
x3_	Output software version of active weighing instrument. Example: “00-37-11 ”
z1_	Activate input for printout header 1
z2_	Activate input for printout header 2
txx...x_	xx...x: Input text Length acc. to input (Signum 3 only)

The ASCII code for the “underline” character is 95.

Format for entering printout header lines: ESC z x a ... a _ CR LF where x=(header line) 1 or 2; a ... a: = up to 20 characters of text, followed by the “underline” character, carriage return and line feed.

Interface Port

Data Output Format

Each line in a print job can contain up to 22 characters (up to 20 printable characters plus two control characters). The first 6 characters, called the “data header”, identify the subsequent value. You can suppress the header under menu item 7.2 in the “Printouts” menu; in this case, the print job has up to 16 characters (up to 14 printable characters plus two control characters).

Examples:

```

Q n t   +       235 p c s   without header
        +       235 p c s   With header
    
```

Display segments that are not activated are output as spaces. Values with no decimal point are output without a decimal point.

Data Output Format with 16 Characters (without Data Header)

Normal Operation:

```

Pos.   1  2  3  4  5  6  7  8  9 10 11 12 13 14 15 16
-----
      +  *  D  D  D  D  D  D  D  *  U  U  U  CR LF
or     -  *  D  D  D  D  D  D  D  *  U  U  U  CR LF
or     *  *  *  *  *  *  *  *  *  *  *  *  *  *  *  CR LF
    
```

- + -: Plus or minus sign
- *: Space
- A: Digit or letter (max. 7 characters plus decimal point)
- U: Unit symbol (1 to 3 letters, followed by 0 to 2 spaces)
- CR: Carriage return
- LF: Line feed

Special Codes:

```

Pos.   1  2  3  4  5  6  7  8  9 10 11 12 13 14 15 16
-----
      *  *  *  *  *  *  -  -  *  *  *  *  *  *  *  CR LF
or     *  *  *  *  *  *  H  *  *  *  *  *  *  *  *  *  CR LF
or     *  *  *  *  *  *  H  H  *  *  *  *  *  *  *  *  CR LF
or     *  *  *  *  *  *  L  *  *  *  *  *  *  *  *  *  CR LF
or     *  *  *  *  *  *  L  L  *  *  *  *  *  *  *  *  CR LF
or     *  *  *  *  *  *  C  *  *  *  *  *  *  *  *  *  CR LF
    
```

- *: Space
- -: Final readout mode
- H: Overload
- HH: Overload in Checkweighing
- L: Underload
- LL: Underload in Checkweighing
- C: Calibration/adjustment

Error Codes:

```

Pos.   1  2  3  4  5  6  7  8  9 10 11 12 13 14 15 16
-----
      *  *  *  E  r  r  *  *  #  #  *  *  *  *  *  CR LF
or     *  *  *  E  r  r  *  #  #  #  *  *  *  *  *  CR LF
    
```

- *: Space
- #: Error code number (2 or 3 digits)

Example (output of value: +1255.7 g):

```

Pos.   1  2  3  4  5  6  7  8  9 10 11 12 13 14 15 16
-----
      +  *  *  *  1  2  5  5  .  7  *  g  *  *  CR LF
    
```

- Position 1: Plus or minus sign or space
- Position 2: Space
- Positions 3–10: Weight value with decimal point; leading zeros are output as spaces.
- Position 11: Space
- Positions 12–14: Unit symbol or space
- Position 15: Carriage return
- Position 16: Line feed

Data Output Format with 22 Characters (with Data Header)

Normal Operation:

```

Pos.   1  2  3  4  5  6  7  8  9 10 11 12 13 14 15 16 17 18 19 20 21 22
-----
      1  1  1  1  1  1  +  *  D  D  D  D  D  D  D  *  U  U  U  CR LF
or     1  1  1  1  1  1  -  *  D  D  D  D  D  D  D  *  U  U  U  CR LF
or     *  *  *  *  *  *  *  *  *  *  *  *  *  *  *  *  *  *  *  CR LF
    
```

- K: ID code character, right-justified with spaces
- + -: Plus or minus sign
- *: Space
- A: Digit or letter (max. 7 characters plus decimal point)
- U: Unit symbol (1 to 3 letters, followed by 0 to 2 spaces)
- CR: Carriage return
- LF: Line feed

Special Codes:

```

Pos.   1  2  3  4  5  6  7  8  9 10 11 12 13 14 15 16 17 18 19 20 21 22
-----
      S  t  a  t  *  *  *  *  *  *  *  *  -  -  *  *  *  *  *  *  CR LF
or     S  t  a  t  *  *  *  *  *  *  *  *  H  *  *  *  *  *  *  *  CR LF
or     S  t  a  t  *  *  *  *  *  *  *  *  H  H  *  *  *  *  *  *  *  CR LF
or     S  t  a  t  *  *  *  *  *  *  *  *  L  *  *  *  *  *  *  *  CR LF
or     S  t  a  t  *  *  *  *  *  *  *  *  L  L  *  *  *  *  *  *  *  CR LF
or     S  t  a  t  *  *  *  *  *  *  *  *  C  *  *  *  *  *  *  *  CR LF
    
```

- *: Space
- -: Final readout mode
- H: Overload
- HH: Overload in Checkweighing
- L: Underload
- LL: Underload in Checkweighing
- C: Calibration/adjustment

Error Codes:

Pos.	1	2	3	4	5	6	7	8	9	10	11	12	13	14	15	16	17	18	19	20	21	22	
	S	t	a	t	*	*	*	*	*	E	r	r	*	*	#	#	*	*	*	*	*	CR LF	
or	S	t	a	t	*	*	*	*	*	E	r	r	*	*	#	#	#	*	*	*	*	*	CR LF

*: Space
#: Error code number (2 or 3 digits)

ID Code Characters

ID character	Meaning
G#	Gross value
N	Net value
T	Application tare memory 1
T	Application tare memory 2
D i f f	Difference from calibration value
T a r g .	Exact calibration weight
N o m .	Exact calibration weight using SBI output
n R e f	Reference sample quantity
p R e f	Reference percentage
w R e f	Reference sample weight
Q n t	Result from Counting application Result from Counting (piece count) and Neutral Measurement applications
m D e f	Target value for Animal weighing
x - N e t	Result from Animal Weighing
S e t p	Target value for Checkweighing
W . D i f f	Absolute difference (e.g., in kg) in Checkweighing
L i m	Deviation in % in Checkweighing
M a x	Upper limit for Checkweighing
M i n	Lower limit for Checkweighing
S t a t	Status
C l a s s x	Classification
L i m x	Class limit
D	Percentage (as loss)
P r c	Percentage (as residue)
W x x %	Reference percentage weight
C o m p x x x	Component xxx
C o n t . T	Contents of the tare memory in Net-total Formulation
T o t . c p	Total weight in Net-total Formulation
P T 2	Preset tare
n	Transaction counter
* G	Sum of gross weights in Totalizing
* N	Sum of net weights in Totalizing
S e r . n o	Serial number of the platform or display and control unit

Example (output of value: +1255.7 g):

Pos.	1	2	3	4	5	6	7	8	9	10	11	12	13	14	15	16	17	18	19	20	21	22
	G	#	*	*	*	*	+	*	*	*	1	2	5	5	.	7	*	g	*	*	CR LF	

Position 1–6:	ID code character, right-justified with spaces
Position 7:	Plus or minus sign or space
Position 8:	Space
Positions 9–16:	Weight value with decimal point; leading zeros are output as spaces.
Position 17:	Space
Positions 18–20:	Unit symbol or space
Position 21:	Carriage return
Position 22:	Line feed

△ If the weight value is output with 10-fold increased resolution, this value is not permitted to be printed or saved in a weighing instrument operated in legal metrology in the SBI mode. In this case, the unit symbol is not included with output.

Configuring the Data Interface as a Printer Port (*PRINTER*)

You can connect one or two strip printers or one or two label printers to the Signum. Configure the COM1 and UniCOM interfaces as printer ports under the “*PRINTER*” menu item.

There are several actions that generate the command for outputting data to the printer port:

- Pressing the  key. If the operating menu is active, all menu settings under the active menu level are printed.
- On receipt of the SBI command “Esc k P _”. For details, see “Data Input Format” in this chapter.
- In some applications, pressing a given key (e.g., to save a value or start a routine) also generates a print command. In this case, a configurable printout is generated with application-specific data.

The  and  symbols are displayed when data is being output to the printer port.

Interface Port

Automatic Data Output (SBI)

You can have results of measurement printed automatically¹⁾. You can configure the autoprint function to print at certain intervals (measured in display updates²⁾ and define whether printing is dependent on stability of the scale³⁾. How often the display is updated depends on the operating status and model of the equipment.

Examples:

N	+	153.00 g	Net weight
Stat			Display blank
Stat	L		Display underload
Stat	H		Display overload

Setting:

- 1) 3) "Automatic output without stability"
or
"Automatic output with stability"
Factory setting: Manual after stability;
i.e., automatic data output function off.
- 2) Time-dependent automatic data output;
Intervals: 1, 2, 10 or 100 display updates
Factory setting: 1 display update











Signum 2 and 3 only External Keyboard Functions (Computer Keyboard)

Configuration

SETUP: BARCODE: EXT.KEYB



The alphanumeric key codes refer to exclusively to the German keyboard layout. The alphanumeric keys are as follows (note: "Shift" key required for some of these characters):
a - z, A - Z, 0 - 9, <space>, Ñ, \+'<>/i\$@%/();=:_?*

Application function keys:

Computer keyboard	Signum 2 and 3
F1	 key
F2	 key
F3	 key
F9	 key
F11	 key
F12	 key
Print	 key
Home	 key
Backspacec key	 key
ESC	 key

GMP-compliant Printout (optional in Signum 1)

When the corresponding menu item is active, the printout is bracketed by a GMP header and a GMP footer (GMP: “Good Manufacturing Practice”).

The GMP header precedes the first measured result. The GMP footer is printed after the last result in a series of measurements (“ISO/GMP/GLP: For several application results,” menu item 7.11.3). To end a series of measured results, press and hold the  key (> 2 seconds). In this case, the  symbol is displayed after the GMP header is printed and remains in the display until the GMP footer is printed.

If you toggle to a different platform (Signum 2 and 3 only) while a GMP printout of several measured results is being generated (menu item 7.11.3), the GMP footer for the platform used up to that point is generated when you press . The GMP header for the other platform is included on the next printout generated.

A GMP-compliant printout is generated automatically at the conclusion of calibration/adjustment, linearization, and when you set or clear a preload.

Three examples of GMP headers and one example of a footer are shown in the following. On Signum 1 models, the “date and time” line is not included.

Weighing platform WP1:

```
-----
14.01.2007      09:43
Typ             SIWR
Ser.no.        12345678
Vers.          1.1007.12.1
BVers.         01-25-01
-----
```

Dotted line
Date and time¹⁾
Signum model
Signum serial no.
Software release for application
Software release for basic version
Dotted line

```
-----
14.01.2007      09:45
Typ             SIWR
Ser.no.        12345678
Vers.          1.1007.12.1
BVers.         01-25-01
Typ            IS12000S
Ser.no         12345678
-----
```

Weighing platform WP2 (XBPI protocol):²⁾
Dotted line
Date and time¹⁾
Signum model
Signum serial no.
Software release for application
Software release for basic version
Weighing platform model
Weighing platform serial no.
Dotted line

```
-----
14.01.2007      09:45
Typ             SIWR
Ser.no.        12345678
Vers.          1.1007.12.1
BVers.         01-25-01
Typ            SBI
-----
```

Weighing platform WP2 (SBI protocol):²⁾
Dotted line
Date and time¹⁾
Signum model
Signum serial no.
Software release for application
Software release for basic version
(Weighing platform model)
Dotted line

```
-----
14.01.2007      09:45
Name:
-----
```

GMP footer:
Dotted line
Date and time¹⁾
Field for operator signature
Blank line
Dotted line

¹⁾ Not applicable for Signum 1 display and control units

²⁾ Signum 2 and 3 only

Error Codes

Error codes are shown on the main display. “Err” codes are shown continuously; “Inf” messages are displayed for 2 seconds, after which the program returns automatically to the weighing mode.

Error code	Cause	Solution
<i>ERR 101</i>	A key is stuck Key pressed when switching on the scale	Release the key, or contact your local Sartorius Service Center
<i>ERR 320</i>	Operating program memory defective	Contact your local Sartorius Service Center
<i>ERR 335</i>	Verified platform not compatible with display and control unit	Connect a compatible weighing platform
<i>ERR 340</i>	Operating parameter (EEPROM) error	Turn the scale off and then on again. If the error code remains displayed, please contact your local Sartorius Service Center
<i>ERR 343</i>	Data lost from the memory area for transaction numbers in Alibi memory	Contact your local Sartorius Service Center
<i>INF 01</i>	Data output not compatible with output format	Adjust the settings in the operating menu
<i>INF 02</i>	Calibration/adjustment condition not met; e.g., scale was not tared, or there is a load on load plate	Calibrate only when zero is displayed Unload the scale Tare the scale by pressing $\rightarrow T \leftarrow$
<i>INF 03</i>	Calibration/adjustment could not be completed within a certain time.	Allow scale to warm up and then repeat the calibration/adjustment process
<i>INF 06</i>	Built-in calibration weight defective*	Contact your local Sartorius Service Center
<i>INF 07</i>	Function not allowed in scales verified for use in legal metrology	Contact your local Sartorius Service Center for information on having the settings changed
<i>INF 08</i>	The load on the scale is too heavy to zero the readout	Check whether the “Tare zero with power-on” condition (menu item 1.12) has been met.
<i>INF 09</i>	Taring is not possible when the gross weight is below zero	Zero the scale
<i>INF 10</i>	Tare key is blocked when there is data in the tare memory	The data stored for the application program must be deleted (clear the memory) before taring.
<i>INF 22</i>	Error in storing reference value, load is too light	Put a heavier sample on the scale
<i>INF 23</i>	Error in initializing an application	Contact your local Sartorius Service Center
<i>INF 29</i>	Minimum load not reached	Define a lower value for the minimum load (in the Application settings, menu item 3.6)
<i>INF 71</i>	Cannot store the current weight value or input (e.g., control limit too low or too high)	None
<i>INF 72</i>	Cannot store the current weight value (e.g., the transaction counter has reached its limit)	None
<i>INF 73</i>	Data not found or unreadable Memory cell number not found or incorrectly allocated	Contact your local Sartorius Service Center Use a memory cell in the appropriate application
<i>INF 74</i>	Function is blocked (e.g., menu is locked)	None
<i>INF 98</i>	No weighing platform connected	Contact your local Sartorius Service Center
<i>INF 99</i>	No weighing platform connected	Contact your local Sartorius Service Center
<i>NO WP</i>	No weighing platform connected	Contact your local Sartorius Service Center

* only for SIWS models

Care and Maintenance

Service

Regular servicing by a Sartorius technician will extend the service life of your Signum scale and ensure its continued weighing accuracy. Sartorius can offer you service contracts, with your choice of regular maintenance intervals ranging from 1 month to 2 years.

The optimum length of the service interval depends on the operating conditions at the place of installation and on your requirements.

Cleaning

- ⚠ Unplug the AC adapter from the wall outlet (mains supply). If you have an cable connected to the interface port, unplug it.
- Clean the scale using a piece of cloth which has been wet with a mild detergent (soap).
- After cleaning, wipe down the scale with a soft, dry cloth.
- ⚠ Make sure that no liquid enters the scale housing.
- ⚠ Do not use any aggressive cleaning agents (solvents or similar agents.)

Cleaning Stainless Steel Surfaces

Clean all stainless steel parts regularly. Remove the stainless steel load plate and thoroughly to clean it separately. Use a damp cloth or sponge to clean stainless steel parts on the scale. You can use any commercially available household cleaning agent that is suitable for use on stainless steel. Clean stainless steel surfaces by wiping them down. Then clean the load plate thoroughly, making sure to remove all residues. Wipe down stainless steel parts again using a clean, damp cloth or sponge and allow the equipment to dry. If desired, you can apply oil to the cleaned surfaces as additional protection.

- ⚠ Solvents are permitted only for cleaning stainless steel parts.

Corrosive Environment

- Remove all traces of corrosive substances on a regular basis.

Replacing the Dust Cover

- > Replace damaged dust covers.
- Place the new dust cover on the display and control unit and press down on the front and back along the edges until the cover is firmly seated.

Safety Inspection

Safe operation of the scale is no longer ensured when:

- there is visible damage to the device or power cord.
- the built-in power supply no longer functions properly.
- the equipment has been stored for a relatively long period under unfavorable conditions (e.g., extreme moisture).
- the equipment has been subjected to rough handling during shipment.

If there is any indication that safe operation of the equipment is no longer warranted:

- Disconnect from power (unplug the equipment from the wall outlet (mains supply))
- > Lock the equipment in a secure place to ensure that it cannot be used for the time being.
- Notify your nearest Sartorius Service Center or the International Technical Support Unit based in Goettingen, Germany.

Maintenance and repair work may be performed only by authorized Sartorius service technicians who:

- have access to the required service and maintenance manuals, and
 - have attended the relevant service training courses.
- ⚠ The seals affixed to this equipment indicate that only authorized service technicians are allowed to open the equipment and perform maintenance work so that safe and trouble-free operation of the equipment is ensured and the warranty remains in effect. If the verification seals are damaged, the equipment must be re-verified.

Recycling

If you no longer need the packaging after successful installation of the equipment, you should return it for recycling. The packaging is made of environmentally friendly materials and is a valuable source of secondary raw material.



The equipment, including accessories and batteries, does not belong in your regular household waste. European legislation requires that electrical and electronic equipment be collected and

disposed of separately from other communal waste with the aim of recycling it.

In Germany and many other countries, Sartorius AG takes care of the return and legally compliant disposal of its electrical and electronic equipment on its own. These products may not be placed with the household waste or brought to collection centers run by local public disposal operations – not even by small commercial operators.

For disposal in Germany and in the other Member States of the European Economic Area (EEA), please contact our Service technicians on location or our Service Center in Goettingen, Germany:

Sartorius AG
Service Center
Weender Landstrasse 94-108
37075 Goettingen, Germany

In countries that are not members of the European Economic Area (EEA) or where no Sartorius affiliates, subsidiaries, dealers or distributors are located, please contact your local authorities or a commercial disposal operator. Prior to disposal and/or scrapping of the equipment, any batteries should be removed and disposed of in local collection boxes. Sartorius AG, its affiliates, subsidiaries, dealers and distributors will not take back equipment contaminated with hazardous materials (ABC contamination) – either for repair or disposal. Please refer to the accompanying leaflet/manual or visit our Internet website (www.sartorius.com) for comprehensive information that includes our service addresses to contact if you plan to send your equipment in for repairs or proper disposal.

Overview

Specifications

Digital protective interface	in accordance with EN45501
Data interface	Bidirectional RS-232 with control outputs (standard equipment)
Additional data interface	optional
Display	14-segments, backlit
Housing: Material	Die-cast aluminum
Ambient conditions: Operating temperature range Humidity	-10°C to 40°C (+14°F to 104°F) Maximum relative humidity 80% for temperature up to 31°C (~88°F); linear decrease down to 50% relative humidity at 40°C (+104°F)
Protection class of the housing in accordance with EN 60529:	IP 65
Pollution degree 2	Normally only nonconductive pollution occurs. Temporary conductivity caused by condensation is to be expected.
Ratings: Power supply Transient overvoltage Operation using protective extra low voltage	100-240 VAC (-15/+10%), 50-60 Hz, 17 W/23 VA max. Overvoltage category II acc. to IEC 60364-4-443 See instruction manual for Option L8 (24-volt module)
DC supply AC supply	22.8 ... 26.7 V (optional: 21.6 ... 26.7 V); 12 VA max. 22.8 ... 26.7 V, 50-60 Hz, 12 VA max.
Operation with rechargeable battery	See Sartorius Installation Instructions for Option L9 Operation via built-in or external rechargeable battery (only available as an option that must be ordered with the scale)
Emissions	Acc. to EN613-1 (IEC 61326-1) Group 1, Class B, suitable for use in domestic establishments and establishments directly connected to a low-voltage power-supply network that supplies buildings used for domestic purposes
Immunity to interference:	Acc. to EN61326-1 (IEC61326-1): Immunity test requirements for equipment intended for use in industrial locations (Table 2)
Electrical safety	Acc. to EN 61010-1 (IEC 61010-1)

Signum Model Designator

Model	Sensor technology	Platform dimensions (mm)	Material/version	Application level	Weighing capacity (kg)	Display resolution	Verifiable/verified versions
SIW	R ¹⁾	DC	P ⁴⁾	1	3	L	
				2	6	I	
				3	15	N	NCE
					35	M	
					60	R	RCE
							BCE

Example, SIWR: SIWRDCP-1-6-L

SIW	A ²⁾	DC	P ⁴⁾	1	16	S	
				2	35		
				3	65		

Example, SIWA: SIWADCP-2-35-S

SIW	S ³⁾	DC	P ⁴⁾	1	6	S	SCE
				2	16	H	HCE
				3	15	K	KCE
					35	T	TCE
						D	DCE
						P	PCE
						I	ICE

Example, SIWS: SIWSDCP-3-16-H

- 1) SIWR = Regular: standard weighing system (strain-gauge system)
- 2) SIWA = Advanced: mechatronic weighing system (strain-gauge system)
- 3) SIWS = Supreme: monolithic weigh cell
- 4) painted

Overview

Details on Available Resolutions

Resolution > 15,000d non-verifiable		
Resolution > 30,000d non-verifiable		
Resolution 2*3000d (fixed fine range) non-verifiable	-NCE	Verifiable, dual range (fixed fine range) Cl. Cl. III 1*3000/3500e
Resolution 2*3000d (adjustable fine range) non-verifiable		
Resolution > 6000d non-verifiable	-RCE	Verifiable, single range Cl. Cl. III 1*6000/7500e
	-BCE	Verifiable, single range Cl. Cl. III 1*3000e
Resolution > 60,000d non-verifiable		
Resolution \geq 60,000d non-verifiable	-SCE	Verified at the factory CE, single range Cl. Cl. II < 10,000e e=10d
Resolution > 100,000d non-verifiable	-SCE	Verified at the factory CE, single range Cl. Cl. II > 10,000e e=10d
Resolution \leq 50,000d (fixed fine range) non-verifiable	-KCE	Verified at the factory CE, dual range (fixed fine range) Cl. Cl. II \leq 5000e
Resolution \leq 50,000d (adjustable fine range) non-verifiable	-TCE	Verified at the factory CE, dual range (adjustable fine range) Cl. Cl. II \leq 5000e
Resolution > 50,000d (fixed fine range) non-verifiable	-DCE	Verified at the factory CE, dual range (fixed fine range) Cl. Cl. II > 5000e
Resolution > 50,000d (adjustable fine range) non-verifiable	-PCE	Verified at the factory CE, single range with variable scale intervals (adjustable fine range) Cl. Cl. II > 5000e
Resolution > 30,000d non-verifiable	-ICE	Verified at the factory CE, single range Cl. Cl. II 30,000e (e=d)

Platform Specifications

Three different types of weighing technology are used in the Signum Series, offering different performance levels.

Signum Regular:

Model code	SIWRDCP-1,-2,-3					
Type, accuracy class	DG SI 300, (III)					
Weighing capacity (kg)	-3				-6	
Resolution code	-I		-N	-R	-L	-I
Weighing capacity (kg)	3	3	3/6	6	6	6
Readability d	0.1	1	1/2	1	2	0.5
Verifiable/verified version	-BCE		-NCE	-RCE	-BCE	
Readability e (g)		1	1/2	1	2	
Preload (kg)	1.2		1		.2	
Repeatability [s] (g)	0.2		Meets EN 45501			0.2
Linearity (g)	0.3		0.4			
Ambient temperature (only for use in legal metrology)	-10°C to +40°C (14°F to 104°F)					
Calibration weight (g)		2,000	5,000	5,000	5,000	5,000
- Accuracy class		M1	M1	M1	M1	M1

Signum Regular:

Model code	SIWRDCP-1,-2,-3					
Type, accuracy class	DG SI 300, (III)					
Weighing capacity (kg)	-15					
Resolution code	-N				-L	-I
Weighing capacity (kg)	6/15		15		15	15
Readability d	2/5		2		5	1
Verifiable/verified	-NCE		-RCE		-BCE	
Readability e (g)			2		5	
Preload (kg)			3		3	3
Repeatability [s] (g)			Meets EN 45501			0.2
Linearity (g)	0.8					
Ambient temperature (only for use in legal metrology)	-10°C to +40°C (14°F to 104°F)					
Calibration weight (g)	5,000					
- Accuracy class	M1					

Signum Regular:

Model code	SIWRDCP-1,-2,-3					
Type, accuracy class	DG SI 300, (III)					
Weighing capacity (kg)	-35					
Resolution code	-N	-R		-L	-I	-M
Weighing capacity (kg)	15/35		35		35	35
Readability d	5/10		5	10	2	1
Verifiable/verified version	-NCE		-RCE	-BCE		
Readability e (g)	5/10		5	10		
Preload (kg)	6					
Repeatability [s] (g)	1					
Linearity (g)	1.5					
Ambient temperature (only for use in legal metrology)	-10°C to +40°C (14°F to 104°F)					
Calibration weight (g)	10,000					
- Accuracy class	M1					

Overview

Signum Regular:

Model code	SIWRDCP-1,-2,-3				
Type, accuracy class	DG SI 300, (III)				
Weighing capacity (kg)	-60				
Resolution code	-N	-R	-L	-I	-M
Weighing capacity (kg)	30/60	60	60	60	30/60
Readability d	10/20	10	5	2	10/20
Verifiable/verified	-NCE	-RCE		-BCE	
Readability e (g)	10/20	10		20	
Preload (kg)	12				
Repeatability [s] (g)	2				
Linearity (g)	3				
Ambient temperature (only for use in legal metrology)	-10°C to +40°C (14°F to 104°F)				
Calibration weight (g)	20,000				
- Accuracy class	M1				

Signum Advanced:

Model code	SIWADCP-1,-2,-3			
Weighing capacity (kg)	-7	-16	-35	-65
Resolution code	-S	-S	-S	-S
Weighing capacity (kg)	7	16	35	65
Readability d	0.1	0.2	0.5	1
Preload (kg)	-			
Repeatability [s] (g)	0.2	0.4	1	2
Linearity (g)	0.3	0.8	2	4
Ambient temperature (only for use in legal metrology)	+10°C to +30°C (14°F to 86°F)			
Calibration weight (g)	2,000	5,000	10,000	20,000
- Accuracy class	F2	F2	F2	F2

Signum Supreme:

Model code	SIWSDCP-1,-2,-3							
Type, accuracy class	BG SI 200, (II)							
Weighing capacity (kg)	-6	-16	-16	-16	15	-35	-35	-35
Resolution code	-S	-H	-K	-T	-I	-D	-P	-H
Weighing capacity (kg)	6	16	3.5/16	3.5/16	15	7/35	7/35	35
Readability d	0.1	0.1	0.1/1	0.1/1	0.5	0.1/1	0.1/1	0.1
Verifiable/verified version	-SCE	-HCE	-KCE	-TCE	-ICE	-DCE	-PCE	-HCE
Readability e (g)	1	1	1	1	0.5	1	1	1
Preload (kg)	5							
Repeatability [s] (g)	0.08 (verified models acc. to EN 45501)							
Linearity (g)	0.2 (verified models acc. to EN 45501)							
Ambient temperature (only for use in legal metrology)	+10°C to +30°C (14°F to 104°F)							
Calibration weight (g)	5,000	10,000	10,000	10,000	10,000	10,000	10,000	10,000
- Accuracy class	F2	F1	F1	F1	F1	F1	F1	F1

Dimensions (Scale Drawings)

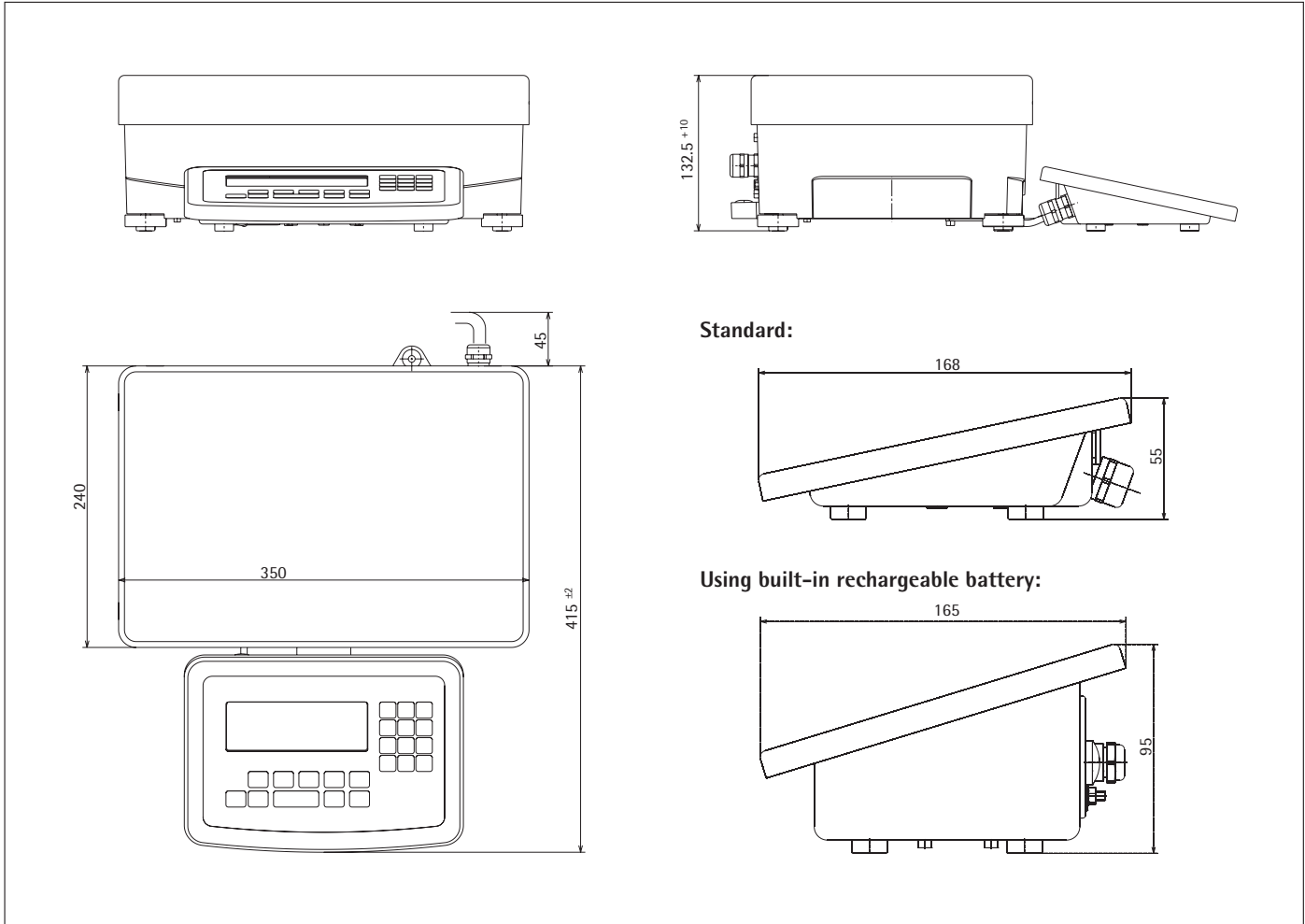

All dimensions are given in millimeters

Overview



YDP03-OCE

Accessories/Options

Printer and printer accessories:

Verifiable printer with functions for date, time and statistical evaluations	YDP03-OCE
Printer paper for data printer (5 rolls; length per roll: 50 m)	6906937
Replacement ink ribbon cartridge	6906918



YDP04IS

Verifiable strip and label printer with thermal print head, up to 60 mm paper width, with external 100–240V power supply Connecting cable required	YDP04IS-OCEUV
	YCC01-01CISLM3
Verifiable strip and label printer with thermal print head, up to 108 mm paper width, with external 100–240V AC adapter and power cord (EU+US); for use only with flexible print formatting, connecting cable required	YDP12IS-OCEUV
	YCC01-01CISLM
Labels for YDP04IS-OCEUV + YDP12IS-OCEUV	
Labels 58×30 mm (1000 pcs)	69Y03092
Labels 58×76 mm (500 pcs)	69Y03093
Labels 58×100 mm (380 pcs)	69Y03094
Labels for YDP12IS-OCEUV	
Labels 101×127 mm (305 pcs)	69Y03195
Printer paper for YDP04IS-OCEUV + YDP12IS-OCEUV	
3 paper rolls; 60 mm × 75 m, thermo paper	69Y03090
for YDP12IS-OCEUV	
1 paper roll; 101 mm × 75 m, thermo paper	69Y03196



YDP12IS

Verifiable strip and label printer with thermal print head, up to 108 mm paper width, with external 100–240V power supply: and power cord (EU+US), for use only with flexible print formatting, connecting cable required.	YDP12IS-OCEUVTH
3 color ink cartridges for YDP12IS-OCEUVTH	69Y03234

Product	Order No.
Interfaces	
UniCOM: RS-232 interface module	YD001SW-232
UniCOM: RS-485/422 interface module	YD001SW-485/422
UniCOM: analog current output interface module 0–20 mA, 4–20 mA, 0–10 V, 16 bit	YD001SW-AO
UniCOM: Ethernet interface module	YD001SW-ETH
UniCOM: digital I/O interface module	YD001SW-DIO
UniCOM: Profibus DP interface module	YD001SW-DP
Cable for connecting RS-232 data interface to USB interface on the PC	YCC01-USBM2
External Bluetooth module (box, external)	YBT01
Adapter plate for retrofitting: UniCOM	YAS01SW-CON
Adapter plate for retrofitting: Ethernet	YAS01SW-ETH
Adapter plate for retrofitting: Profibus	YAS01SW-DP
Electrical Accessories	
External red/green/red display	YRD14Z
Second (remote) display (not for use in legal metrology)	YRD02Z
Bar code scanner, 120 mm scanning width, with cable for Signum 2 and 3	YRB02-PS2
Foot switch, incl. D-Sub 25-pin T-connector	YFS01
Hand switch, incl. D-Sub 25-pin T-connector	YHS02
External Alibi memory for electronic storage of weighing data	YAM01IS
Scanner for loading weighing data in a PC from YAM13IS card	YAM02IS
Power supply for YAM01IS or YAM02IS	YAM11IS
Memory card for YAM01IS	YAM13IS
Cable for YD0015W-AO current interface, with open cable ends; for example, 5x = 5m	6906926
Cable for connecting Signum display and control unit o YAM01IS Alibi memory	YCC01-10CIM3
Cable (D-Sub 9-pin) for connecting YAM01IS Alibi memory to a computer	69EM0012
Software	
Flexible formatting options for printouts (e.g., bar code, variable sizes, sizes, inserting graphics, etc.)	YAD02IS
Sartorius WinScale driver software for Windows 95/98/2000/NT. Displays the scale readout on your computer monitor and provides secure memory for storing data that is subject to legal control. YCC01-09ISM5 RS-232 connecting cable required (RS-485 cable available on request)	YSW03
SartoConnect data transfer software (for loading weight values in a computer running Windows 95/98/NT and processing with an application program such as MS Excel, Access, etc.) incl. adapter cable (1.5 m) from weighing instrument to computer (12-pin to 9-pin)	YSC01L
Mechanical Accessories	
Column (for mounting display and control unit)	YDH01P
Stainless steel wall-mounting bracket, tiltable	YDH01CIS
Stainless steel wall-mounting bracket	YDH02CIS
Dust covers (set of 2)	YDC01SW

Declarations of Conformity

In 1985, the Council of the European Community approved a resolution concerning a new approach to the technical harmonization and standardization of national regulations. Monitoring compliance with the directives and standards concerning the C marking is governed in the individual EU Member States through the implementation of the EC Directives adopted by the respective national laws. As of December 1993, the scope of validity for all EC Directives has been extended to the Member States of the European Union and the Signatories of the Agreement on the European Economic Area.

Sartorius complies with the EC Directives and European Standards in order to supply its customers with weighing instruments and related equipment that feature the latest technology and provide many years of trouble-free service.

The **CE** marking is affixed only to weighing instruments and associated equipment that comply with the following Directives:

Council Directive 89/336/EEC: "Electromagnetic compatibility (EMC)"

Applicable European Standards:

1. Electromagnetic compatibility:
 - 1.1 Reference to 89/336/EEC:
Official Journal of the European Communities, No. 2001/C105/03
EN 61326-1 Electrical equipment for measurement, control and laboratory use EMC requirements
Part 1: General requirements
Defined immunity to interference:
Industrial areas, continuous un-monitored operation
Limitation of emissions: Residential areas, Class b

Note:

The operator shall be responsible for any modifications to Sartorius equipment (not permitted in legal metrology!) and for any connections of cables or equipment not supplied by Sartorius and must check and, if necessary, correct these modifications and connections. On request, Sartorius will provide information on the minimum operating specifications (in accordance with the Standards listed above for defined immunity to interference).

Council Directive 73/23/EEC "Electrical equipment designed for use within certain voltage limits"

Applicable European Standards:

- EN 60950 Safety of information technology equipment including electrical business equipment
- EN 61010 Safety requirements for electrical equipment for measurement, control and laboratory use
- Part 1: General requirements

If you use electrical equipment in installations and under ambient conditions requiring higher safety standards, you must comply with the provisions as specified in the applicable regulations for installation in your country.

Weighing Instruments for Use in Legal Metrology: Council Directive 90/384/EEC "Non-automatic weighing instruments"

This Directive regulates the determination of mass in legal metrology. The Declaration of Type Conformity for weighing instruments verified by Sartorius for use as legal measuring instruments that have an EC Type-Approval Certificate is included with the respective documentation as follows:

- Signum Scale: this manual
- Sartorius weighing module (e.g., IS...-CE) connected to Signum: weighing module manual
- Signum with Option A15 (A/D converter for connecting a reference scale):
 - Sartorius platform: platform manual
 - Platform from a different manufacturer: Option A15 manual or the enclosed "Guide to Verification" (on CD-ROM).

This Directive also regulates EC verification by the manufacturer, provided that an EC Type-Approval Certificate has been issued and the manufacturer has been accredited by an officer of a Notified Body registered at the Commission of the European Community for performing such verification. The legal basis for EC verification is EC Directive No. 90/384/EEC for non-automatic weighing instruments, which has been in effect since January 1, 1993, within the Single European Market, and the accreditation of the Quality Management System of Sartorius AG by Lower Saxony's Regional Administrative Department of Legal Metrology (Niedersächsische Landesverwaltungsamt – Eichwesen) from February 15, 1993. For additional information on the **CE** mark on Sartorius equipment, see Sartorius Publication No. W- 0052-e93081.

"EC Verification" – A Service Offered by Sartorius

Our service technicians authorized to perform the verification* of your weighing instruments that are acceptable for legal metrological verification can inspect and verify the metrological specifications at the place of installation within the Member States of the European Union and the Signatories of the Agreement on the European Economic Area.

Subsequent Verifications within the European Countries

The validity of the verification will become void in accordance with the national regulations of the country in which the weighing instrument is used. For information on verification and legal regulations currently applicable in your country, and to obtain the names of the persons to contact, please contact your local Sartorius office, dealer or service center. For more information on the verification of weighing instruments for use in legal metrology, contact the Sartorius Service Center.



Declaration of Conformity to Council Directives 89/336/EEC, 2006/95/EEC and 94/9/EEC

The modular electronic precision weighing instrument of the series SIW.DC.-.-.-...

meets the applicable requirements of the test standards listed below, in conjunction with auxiliary peripheral devices and installation equipment listed in Annex A2 (see Annex A1 for a technical description and a list of the individual versions).

1. Electromagnetic Compatibility

1.1 DIN EN 61326-1 Electrical equipment for measurement, control and laboratory use - EMC requirements —

Part 1: General requirements (IEC 61326-1:2005); German version EN 61326-1:2006

1.2 Test report no.: SAG.07.EMC.001, SAG.07.EMC.004, SAG.07.EMC.005, 0343, 0352, 0353, 0354

2. Safety of Electrical Equipment

2.1 DIN EN 61010-1 Safety requirements for electrical equipment for measurement, control and laboratory use —

Part 1: General requirements (IEC 61010-1:2001); German version EN 61010-1:2001

2.2 Test report no.: SAG.06.LVD.003

3. Equipment or protective systems or components intended for use in potentially explosive atmospheres and for use in presence of combustible dust

3.1 DIN EN 60079-0 Electrical apparatus for explosive gas atmospheres —

Part 0: General requirements (IEC 60079-0:2004); German version EN 60079-0:2004

DIN EN 60079-15 Electrical apparatus for explosive gas atmospheres —

Part 15: Construction, test and marking of type of protection "n" electrical apparatus (IEC 60079-15:2005); German version EN 60079-15:2005

3.2 DIN EN50014 Electrical apparatus for potentially explosive atmospheres —

General requirements; German version EN 50014:1997. + Corrigendum:1998 + A1:1999 + A2:1999

DIN EN 50281-1-1 Electrical apparatus for use in the presence of combustible dust —

Part 1-1: Electrical apparatus protected by enclosures; construction and testing; German version EN 50281-1-1:1998 and amendment A1:2002

3.3 Test report no.: SAG.06.ATEX.003

Sartorius AG
37070 Goettingen, Germany
2007

C. Oldendorf
Vice President, R&D, Technological Operations
& Innovations and Authorized Officer
Mechatronics Division

Dr. D. Klausgrete
Head of
International Certification Management
Mechatronics Division



Declaration of Type Conformity to Directive No. 90/384/EEC

This declaration is valid for non-automatic electromechanical weighing instruments for use in legal metrology. These weighing instruments accepted for legal metrological verification have an EC Type-Approval Certificate. The model(s) concerned is (are) listed below along with the respective type, accuracy class, and EC Type-Approval Certificate number:

Model	Weighing instrument type	Accuracy class	EC type-approval certificate no.
SIWS...-CE	BG SI 200	II	D07-09-010
SIWR...-CE	DG SI 300	III	D07-09-010

SARTORIUS AG declares that its weighing instrument types comply with the requirements of the Council Directive on non-automatic weighing instruments, no. 90/384/EEC of 20 June 1990; the associated European Standard "Metrological aspects of non-automatic weighing instruments," No. EN 45501; the most recently amended versions of the national laws and decrees concerning legal metrology and verification in the Member States of the European Union, the EU, and the Signatories of the Agreement on the European Economic Area, which have adopted this Council Directive into their national laws; and with the requirements stipulated on the Type-Approval Certificate for verification. This Declaration of Type Conformity is valid only if the ID label on the weighing instrument has the CE mark of conformity and the green metrology sticker with the letter

"M" stamped on it (the two-digit number in large print stands for the year in which the mark was affixed):



If these marks are not on the ID label, this Declaration of Type Conformity is not valid. Validity can be obtained, for example, by submitting the weighing instrument for final processing by an authorized representative of SARTORIUS AG. The period of validity of this Declaration of Type Conformity shall expire upon any tampering with, repair or modification of this weighing instrument or, in some Member States, on the date of expiration. This declaration applies only to the weighing instrument without peripheral devices.

The operator of this weighing instrument shall be responsible for obtaining an authorized renewal of the verification, such as subsequent or periodic verification, of the weighing instrument for use as a legal measuring instrument.

Sartorius AG
37070 Goettingen, Germany
Signed in Goettingen on 06 June 2007

Dr. G. Maaz
President of the Mechatronics Division

J. Rehwalde
Head of the Production Department
Mechatronics / Weighing Technology Division



EG-Bauartzulassung

EC type-approval certificate

Zulassungsinhaber: Sartorius AG
Issued to:
Weender Landstr. 94-108
37075 Göttingen

Rechtsbezug: § 13 des Gesetzes über das Mess- und Eichwesen (*verification act*)
In accordance with: vom/dated 23. März 1992 (BGBl. I S. 711), zuletzt geändert am (*last amended on*) 02.02.2007 (BGBl. I S. 58), in Verbindung mit Richtlinie (*in connection with council directive*) 90/384/EWG, geändert durch (*amended by*) 93/68/EWG

Bauart: Nichtselbsttätige elektromechanische Waage mit oder ohne Hebelwerk
In respect of: *Nonautomatic electromechanical weighing instrument with or without lever system*

Typ / Type: BG SI 200, DG SI 300, DX SI 300
Max 0,1 kg ... 300 t Option: Mehrbereichs- und Mehrteilungswaage
multi-interval and multiple range instrument
Ⓜ n ≤ 35000, ⓂⓂ n ≤ 7500, ⓂⓂⓂ n ≤ 1000

Zulassungsnummer: D07-09-010
Approval number:

Gültig bis: 21.05.2017
Valid until:

Anzahl der Seiten: 15
Number of pages:

Geschäftszeichen: PTB-1.12-4029663
Reference No.:

Benannte Stelle: 0102
Notified Body:

Im Auftrag Braunschweig, 22.05.2007
By order

Marcus Link



Siegel
Seal

Plates and Markings

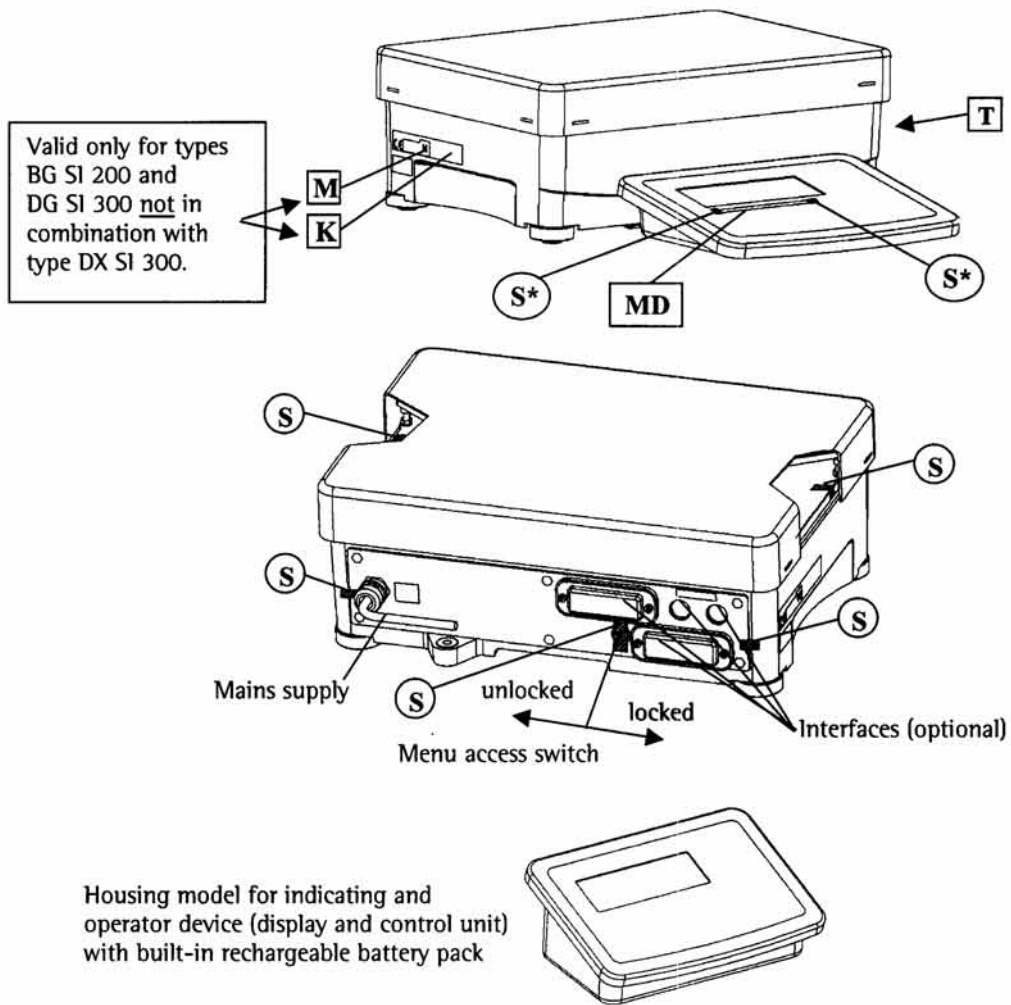

- K** Descriptive plate (ID label) with CE mark
- M** Green metrology sticker
- S** Protective mark (self-adhesive label or seal)
- S*** Protective mark, for transferable labels only (detachable labels that remain intact after removal)
- MD** Metrological data: Max, Min, e and d
- T** Plate with model designation

Valid for types
BG SI 200 and
DG SI 300 in
combination with
type DX SI 300

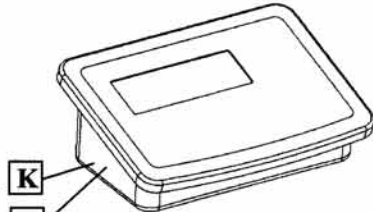

Housing model for indicating and operator device (display and control unit): type DX SI 300 with Option A15 (optional built-in ADC)

Locking plate over menu access switch:
the plate and one screw on the circuit board must be secured

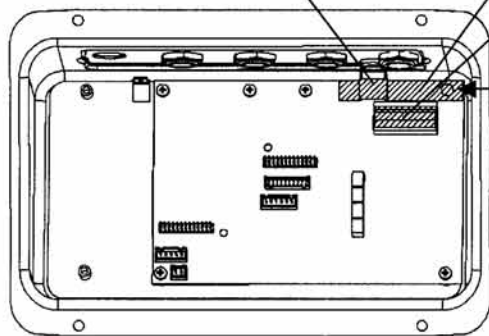

Valid only
for type
DX SI 300

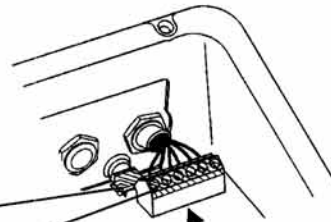

Load receptor connection

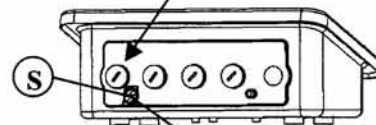

unlocked ← → locked
Menu access switch

Alternative separable plug connection between indicator and load receptor for type DX SI 300

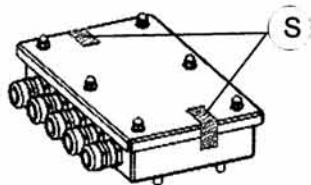
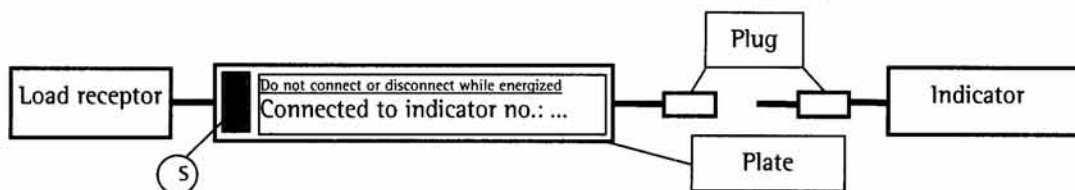

If there is a junction box between the load receptor and the electronic evaluation unit, it must be secured against tampering (type DX SI 300 only).

For type BG SI 200 or DG SI 300 without type DX SI 300

Example of descriptive plate on a weighing instrument that has been verified **K**

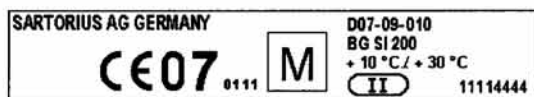

Example of plate with model designation **T**



Example of label with metrological data **MD**



For type BG SI 200 or DG SI 300 in combination with type DX SI 300
(not for type DX SI 300 alone)

Example of descriptive plate on a weighing instrument that has been verified **K**



Example of plate with model designation **T**

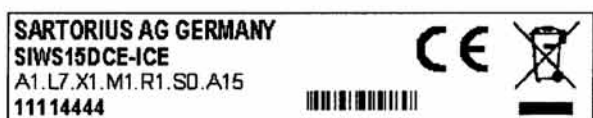

Example of labels with metrological data **MD**

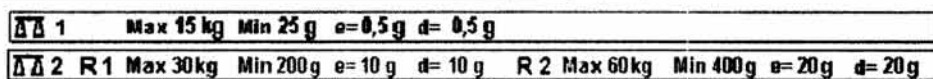

Example of plate with platform model designation for type DX SI 300

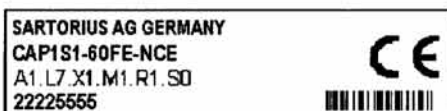

Index

	Page		Page
Access code	17	Maintenance	92
Accessories	98, 99	Net-total formulation	74
Adjustment/calibration	25, 42	Neutral measurement	55
Animal weighing	58	Operating design	10
APW update	53	Operating menu overview	18
Automatic data output	86, 89	Operating menu parameters, overview	18
Averaging	58	Operation	38
Bar code scanner, connecting	83	Password	17
CE declaration of type conformity	102	Password, general	Appendix
CE marking	101	Pin assignment charts	84
Cabling diagram	85	Plates and markings	105
Calibration/adjustment	25, 42	Printer, configuring	28, 29
Checkweighing	64	Printing	81
Classification	68	Printout, Samples	82
Cleaning	92	Printout, settings	81
COM1 interface, settings	26	PS2 socket	84
Commands	86	Recycling	92
Configuration	14	Repairs	92
Connecting the equipment to AC power	8	Safety inspection	92
Connection options	84, 85	Safety instructions	4
Control output ports	33, 65, 69	Sample printouts	82
Control input ports	33, 65, 69	SBI communication	86
Counting	51	Scale drawings	97
Data input format	86	Setting the time	18, 37
Data interfaces	83	Shutoff, automatic	36
Data output format	87	Specifications	93
Data output, configuring	86	Stainless steel surfaces, cleaning	92
Data record, settings	26, 27, 28	Startup	5
Data records: Samples	81	Switch, remote (external)	32
Date and time, setting	18, 37	Technical advice on applications	2
Declarations of conformity	100	Totalizing	71
Device parameters	24, 37	Universal interface	83
Device-specific information	37	Unpacking the equipment	5
Dimensions	97	Warmup time	5
Display elements	12	Warnings and safety precautions	4
Equipment supplied	5	Weighing in percent	61
Equipment, general view	9	Weighing platform WP1, settings	24
Error codes	91	Weighing	38
General password	Appendix		
Geographical data, entering	5		
GMP-compliant printouts	90		
ID codes	48		
Installation	5		
Intended use	2		
IP protection ratings	4, 93		
Keys, functions of	10, 11		
Language, setting	16, 37		
Legal metrology, use in	4		
Leveling the platform	8		

Appendix: General Password



When you select the Setup menu item, the password prompt is displayed for 2 seconds, and then



cursor flashes in the position of the first characters of the password.

Repeatedly: , ;

Repeatedly: , ;

Repeatedly: , ;

Repeatedly: , ;





Repeatedly: , ;

Repeatedly: , ;

Repeatedly: , ;

Repeatedly: , ;



- Enter the password
 - Press  to enter letters and  to save.
 - Press the  key (to scroll through numbers in ascending order: 0 to 9) or the  key (to scroll through numbers in descending order: (9 to 1, and then 0) as often as needed to enter the desired characters.
 - If your password is longer than 7 characters, the display scrolls to the right to show the last character.

The password entered is now displayed.

Confirm the password as entered



Return to next higher menu level

 press and hold

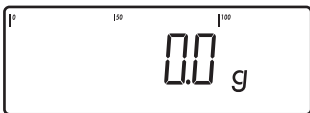

Save setting and exit the operating menu

**General Password:
40414243**

Sartorius AG
Weender Landstrasse 94–108
37075 Goettingen, Germany

Phone +49.551.308.0
Fax +49.551.308.3289
www.sartorius.com

Copyright by Sartorius AG,
Goettingen, Germany.
All rights reserved. No part
of this publication may
be reprinted or translated in
any form or by any means
without the prior written
permission of Sartorius AG.
The status of the information,
specifications and illustrations
in this manual is indicated
by the date given below.
Sartorius AG reserves the
right to make changes to the
technology, features,
specifications and design of the
equipment without notice.

Status:
July 2007, Sartorius AG,
Goettingen, Germany